

The EH domain of EHD3 is required, but not sufficient, to cause its aggregation

Ukić, Ema

Master's thesis / Diplomski rad

2023

Degree Grantor / Ustanova koja je dodijelila akademski / stručni stupanj: **University of Rijeka / Sveučilište u Rijeci**

Permanent link / Trajna poveznica: <https://um.nsk.hr/um:nbn:hr:193:134090>

Rights / Prava: [In copyright](#) / [Zaštićeno autorskim pravom.](#)

Download date / Datum preuzimanja: **2025-02-16**

Repository / Repozitorij:

BIotech

[Repository of the University of Rijeka, Faculty of Biotechnology and Drug Development - BIOTECHRI Repository](#)



UNIVERSITY OF RIJEKA
DEPARTMENT OF BIOTECHNOLOGY
Graduate university programme
Biotechnology in Medicine

Ema Ukić

**The EH domain of EHD3 is required, but not sufficient, to cause its
aggregation**

Master's thesis

Rijeka, 2023.

Mentor: Dr. Nicholas J. Bradshaw, PhD

SVEUČILIŠTE U RIJECI
ODJEL ZA BIOTEHNOLOGIJU
Diplomski sveučilišni studij
Biotehnologija u medicini

Ema Ukić

EH domena EHD3 proteina je potrebna, ali ne i dovoljna, za njegovu agregaciju

Diplomski rad

Rijeka, 2023.

Mentor: izv.prof.dr.sc Nicholas J. Bradshaw

Acknowledgements

To my mentor, Nicholas J. Bradshaw. I am so grateful for the opportunity to be a part of your research team and to learn and work alongside you. Thank you for all your patience, time, and helpful advice.

I would also like to greatly thank Beti Zaharija and Bobana Samardžija. You not only provided assistance and resolved problems when they occurred but were true friends who kept me motivated and cheered me on when I needed it. I could never thank you enough for all your help.

To my dear lab mates – Lana Par and Matea Kršanac. During our long hours in the lab, we became true friends. Thank you for all the laughter, coffee breaks, origami flowers and listening to my rants after a long day in the lab. Also, thank you for lending me a helping hand when I needed it.

Lastly, to my beloved friends and family. Thank you for always believing in me, being my support system as well as my biggest motivators every step of the way.

Master's thesis was defended on 26th of September 2023

In front of the Committee:

1. prof. dr. sc. Miranda Mladinić Pejatović
2. prof. dr. sc. Mladen Merćep
3. izv.prof. dr. sc. Nicholas Bradshaw

This thesis has pages, 4 tables, 12 figures and 32 citations.

Abstract

Schizophrenia is a serious mental illness characterised by impaired perception of reality and changes in behaviour. The molecular background of schizophrenia is not yet fully known. In addition to genetic and environmental factors, protein aggregation is being researched as one of the possible causes of schizophrenia. Protein aggregation occurs when, affected by endogenous and external stresses, cellular mechanisms get disrupted, resulting in protein misfolding and protein aggregates accumulating. EH-domain containing 3 (EHD3) is a protein that has been found to aggregate in the brains of schizophrenia patients. EHD3 is a protein involved in endocytic trafficking and recycling as well as D1 receptor internalization. Full length EHD3 has been shown to aggregate in SH-SY5Y cells, while two constructs lacking the C-terminus of the protein, EHD3 amino acids 1-434 and 1-399, did not aggregate. This implied that amino acids 435-535, representing its EH domain, were required for aggregation. Also, full length EHD3 has been shown to induce EHD3 1-399 to aggregation when co-expressed. In this thesis we aimed to determine if the EH domain aggregates independently and if it would co-aggregate when co-expressed with full length EHD3. When expressed individually, EHD3 435-535 did not aggregate, implying that the EH domain is not sufficient for EHD3 aggregation by itself. When co-expressed with full length EHD3, EHD3 1-399 and EHD3 1-434 the EH domain also did not aggregate, which might imply that while the EH domain is necessary for the initialization of EHD3 aggregation, other structural regions like the helical and/or the G domain interact and recruit other molecules that make up the aggregates. Future research is needed to determine which EHD3 regions interact with the EH domain causing the protein to aggregate and co-aggregate in the cell.

Key words: schizophrenia, protein aggregation, EHD3

Sažetak

Šizofrenija je ozbiljna mentalna bolest koju karakteriziraju narušena percepcija stvarnosti i promjene u ponašanju pojedinca. Molekularni mehanizmi šizofrenije još uvijek nisu dovoljno istraženi. Uz poznate genetske i okolišne čimbenike, agregacija proteina se istražuje kao potencijalni uzrok šizofrenije. Do agregacije proteina dolazi kada se uslijed različitih endogenih i mehaničkih stresova naruše stanični mehanizmi što rezultira pogrešnim slaganjem proteina i nakupljanjem njihovih agregata. EH-domain containing 3 (EHD3) protein jedan je od proteina koji su identificirani kao agregirajući u mozgovima pacijenata oboljelih od šizofrenije. To je protein koji sudjeluje u endosomalnom transportu i recikliranju te u internalizaciji D1 receptora. Dokazano je kako EHD3 agregira u SH-SY5Y staničnoj liniji, dok konstrukti kojima nedostaje C-terminalna regija, EHD3 1-434 i EHD3 1-399 ne agregiraju, Ovo upućuje kako su aminokiseline 435-535, koje predstavljaju EH domenu proteina, nužne za njegovu agregaciju. Također je pokazano kako EHD3 može inducirati agregaciju EHD3 1-399 kada se zajedno eksprimiraju u stanici. U ovom radu nastojali smo pokazati agregira li EH domena samostalno u stanici, te hoće li ko-agregirati s cijelim EHD3 proteinom ukoliko se zajedno eksprimiraju. EHD3 435-535 (sadrži isključivo EH domenu) ne agregira kada se samostalno eksprimira u stanici, niti su cijeli EHD3, EHD3 1-399 i EHD3 1-434 inducirali njegovu agregaciju. Ovo upućuje da je EH domena ključna za inicijalizaciju agregacije EHD3 proteina, no druge strukturalne regije proteina, poput zavojnica i G domene, su potrebne za interakciju i regrutaciju drugih molekula koje izgrađuju agregat. Daljnja istraživanja potrebna su kako bi odredili koje to regije stupaju u interakciju s EH domenom rezultirajući agregacijom i ko-agregacijom EHD3 proteina.

Ključne riječi: šizofrenija, agregacija proteina, EHD3

Table of contents

1. INTRODUCTION	1
1.1. SCHIZOPHRENIA	1
1.2. GENETICS AND BIOLOGICAL THEORIES OF SCHIZOPHRENIA	4
1.3. PROTEIN AGGREGATION	7
1.4. EPS15 HOMOLOGY DOMAIN-CONTAINING PROTEIN 3 (EHD3).....	12
2. AIMS OF THE THESIS	17
3. METHODS AND MATERIALS	18
3.1. SIZE MARKERS	18
3.2. ANTIBODIES AND FLUORESCENT MARKERS	18
3.3. PLASMIDS AND VECTORS.....	19
3.4. BACTERIAL TRANSFORMATION.....	20
3.5. BACTERIAL LIQUID CULTURE AND PLASMID DNA PURIFICATION	20
3.6. MEASURING DNA CONCENTRATIONS	21
3.7. LR CLONASE REACTION	22
3.8. AGAROSE GEL ELECTROPHORESIS	22
3.9. CELL CULTURE	22
3.9.1. Cell splitting	23
3.9.2. Transfecting cells	24
3.9.3. Cell lysis	25
3.10. WESTERN BLOT	25
3.10.1. Preparing acrylamide gels	25
3.10.2. SDS-PAGE	26
3.10.3. Transferring to membrane.....	27
3.10.4. Antibody staining.....	27
3.11. IMMUNOCYTOCHEMISTRY	28

3.11.1. Fixation and permeabilisation	28
3.11.2. Cell staining.....	28
4. RESULTS	29
4.1. VERIFYING EHD3 FRAGMENTS BY WESTERN BLOTTING	29
4.2. EXPRESSING EHD3 FRAGMENTS IN SH-SY5Y CELL LINE AND HEK293 CELL LINE BY FLUORESCENT MICROSCOPY	32
4.2.1. Replicating and confirming results from previous research 32	
4.2.2. Expressing EHD3 plasmids in HEK293 cell line by fluorescent microscopy.....	33
4.2.3. Expressing EHD3 plasmids in SH-SY5Y cell line by fluorescent microscopy.....	35
4.3. EXPRESSING NOVEL EHD3 FRAGMENTS IN SH-SY5Y CELL LINE BY FLUORESCENT MICROSCOPY	37
4.4. AGGREGATING EHD3 FRAGMENTS DO NOT INDUCE THE AGGREGATION OF NON-AGGREGATING EHD3 435-535	39
5. DISCUSSION	43
5.1. THE EH DOMAIN DOES NOT AGGREGATE INDEPENDENTLY, THE AGGREGATION OF EHD3 IS MOST LIKELY INFLUENCED BY MORE THAN ONE STRUCTURAL REGION.....	43
5.2. EXPRESSION OF EHD3 435-535 IS NOT ALTERED IN THE PRESENCE OF FULL LENGTH EHD3, EHD3 1-434 OR EHD3 1-399.	46
5.3. FUTURE RESEARCH	48
6. CONCLUSION	50
7. LITERATURE.....	52

1. Introduction

1.1. Schizophrenia

According to World Health Organisation (WHO), 1 in every 8 people in the world suffered from a mental disorder in 2022 (1). Serious mental illnesses (SMIs) are a smaller and more severe subset of all mental illnesses defined as mental, emotional, or behavioural disorders which result in serious functional impairment interfering or limiting a person's major life activities. SMIs include major depression disorder, schizophrenia, and bipolar disorder. In 2021 5.5% (14,1 million people) of the adult U.S. population suffered from some type of SMI (2).

Schizophrenia is an SMI characterised by significant impairments in the perception of reality and changes in behaviour (1). Core symptoms of schizophrenia can be divided into positive symptoms, negative symptoms, and cognitive impairments. Positive symptoms include those that indicate a loss of contact with reality, such as persistent delusions and hallucinations. Negative symptoms include anhedonia, asociality, paucity of speech and avolition. Other symptoms include manic symptoms, psychomotor symptoms and depressive symptoms (3)(4)(5). Diagnostic requirements for schizophrenia, according to the International Classification of Disorders (ICD-11), are the presence of at least two of the mentioned symptoms over a period of one month or longer (4). There are no biomarkers or diagnostic tests in use yet, so the diagnosis of schizophrenia, according to detailed criteria laid down in the ICD or the Diagnostic and Statistical Manual of Mental Disorders (DSM), is currently made clinically, based on history and mental state examination. Based on the duration of illness, nature and pattern of associated substance abuse, presence of somatic illness and the

co-occurrence of depression or mania there are a couple of differential diagnoses. These include affective psychoses, other, closely related, non-affective psychoses, substance induced psychotic disorders and psychotic disorders due to a general medical condition (4). Since schizophrenia patients differ vastly amongst themselves in their symptoms, treatment response, disease course and outcome a dimensional approach to diagnosing this disorder has been suggested as an attempt for more accurate and effective diagnosing. This would take into account severity rating of schizophrenia symptoms (3)(5).

Similar to many other neuropsychiatric illnesses, the average age of onset for schizophrenia is late adolescence to early twenties, which may be connected with brain changes during this period. The onset is slightly later in females than in males (6). The disease affects around 1% of the world's population which ranks it among the top 10 causes of global disability (1). Prevalence does not vary widely across countries nor are any sex differences observed. Schizophrenia contributes immensely to the burden of disease globally since people suffering from schizophrenia are more likely to experience poverty, homelessness, unemployment and have trouble completing self-care tasks, making them rely on support from family or mental health services. The burden associated with the disease is especially affected by the early onset of the disorder and low remission rate (7).

Currently, the main model for schizophrenia treatment is the biopsychosocial model which includes three aspects of treatment: biological therapeutic methods, psychotherapeutic approaches, and psychosocial treatments. Biological therapeutic methods involve the administration of antipsychotic drugs. Due to poor understanding of underlying biological pathways these drugs mainly act as a way of reducing the symptoms of the disorder. In many cases patients require life-long treatment with antipsychotic drugs. First-generation antipsychotic drugs act by non-selectively blocking

dopamine D2 receptors in the brain which can result in a range of side effects. These include phenothiazines such as chlorpromazine and butyrophenones such as benperidol, droperidol and haloperidol. Second-generation antipsychotic drugs have a higher ability to block 5-HT_{2A} receptors than dopamine D2 receptors which results in less side-effects. This group includes clozapine, olanzapine, quetiapine, risperidone, paliperidone, ziprasidone and molindone. Third-generation antipsychotics include aripiprazole, brexpiprazole and cariprazine. This group acts as D2 receptor partial agonists. Since single-target drugs have very limited efficiency in schizophrenia and other complex psychiatric disorders, efforts are being made in developing substances that could act simultaneously on several molecular targets. Also, new potential drug targets are being considered. These include G-protein coupled receptors (GPCRs), glutamate and nicotinic targets (8)(5)(3). Psychotherapeutic approaches for treating schizophrenia require a multi-disciplinary approach from a wide range of health-care professionals which offer psychological and social support. They act based on research on specific psychological aspects of schizophrenia pathophysiology, for example cognitive training to overcome cognitive impairments. Third aspect, psychosocial treatments, include treatments aimed at workplace rehabilitation and offer educational support and rehabilitation (3)(5). New ways for treatment of schizophrenia that are being developed include a wide range of approaches. Besides developing novel pharmacologic agents, new approaches to psychotherapy and somatic therapies (such as transcranial magnetic stimulation and deep brain stimulation) are being researched. Other important aspects of therapy that need to be improved are early need-based, personalised interventions and implementing guidelines and more effective care models to improve mental health care (5).

1.2. Genetics and biological theories of schizophrenia

Schizophrenia is a complex and heterogeneous disease whose origins are still not completely clear. Current hypotheses of schizophrenia are based on genetic and/or environmental disruption of brain development.

Genetic factors play an important role in developing schizophrenia. Genome-wide association studies (GWAS) have identified more than 300 loci containing genes relevant for developing this disease and the hereditary burden of the disorder has been estimated at 80% (9). Genetic factors linked to schizophrenia are small nucleotide polymorphisms (SNPs), changes in gene expression and copy number variations (CNVs). The majority of risk variants have been found in non-coding regions of the genome, lncRNAs and miRNAs. One of the most established risk factors for schizophrenia is microdeletions in chromosomal region 22q11.2, where the gene for catechol-O-methyltransferase (COMT), a major dopamine catabolic enzyme, is located (9). The major histocompatibility complex (MHC) locus on chromosome 6 is also strongly linked to schizophrenia. It contains genes for adaptive immunity, and the decreased expression of genes encoding CSMD1 and CSMD2, regulators of complement component 4A, have been associated with schizophrenia (9). The gene most strongly associated with schizophrenia is the one encoding the protein disrupted in schizophrenia 1 (DISC1). A translocation between exons 8 and 9 on this gene makes it incapable of dimerization and may cause it to interact with other proteins (9). Some of the other genes that have been associated with the development of schizophrenia are the genes encoding for neuregulin 1 and neuregulin 3, the gene encoding dystrobrevin-binding protein 1 (dysbindin or DTNBP1), the gene encoding synaptosomal-associated protein SNAP25 and the gene encoding transcription factor 4 (TCF4) but they are not yet sufficiently researched (3)(9).

Environmental risk factors interplaying with genetics are another important aspect that affects the onset and severity of schizophrenia. Prenatal and perinatal periods of development are characterised by great neural vulnerability to environmental insults. Risk factors for developing schizophrenia that affect early neurodevelopment during pregnancy include maternal stress, maternal infections (such as herpes simplex infection), nutritional deficiencies, pregnancy and birth complications (such as maternal hypertension, hypoxia, premature rupture of membranes) and prenatal viral and bacterial infections and inflammation (3)(9). The most important postnatal risk factors include stress factors such as childhood trauma, urban living, migration, and cannabis use. The vulnerability-stress model of schizophrenia proposes that such stressful events, especially in key periods of neural development, lead to the sensitization of the subcortical dopamine system and increase the risk of developing schizophrenia (9). Abnormal brain neurodevelopment due to genetic and environmental factors affecting it years before the onset of the disease results in higher risk of developing schizophrenia. This involves changes in brain neuroplasticity, impaired synaptic plasticity, and synaptic efficacy. This approach is called the neurodevelopmental model of schizophrenia (9).

Neurochemical hypotheses aim to explain the underlying biological pathways that occur in schizophrenia. The most well-known theory is the dopamine hypothesis. It claims psychotic symptoms of the disease are related to abnormally low prefrontal dopamine activity, which causes negative symptoms. In return this leads to excess dopamine activity in mesolimbic dopamine neurons, which causes positive symptoms. Most of the drugs present on the market target dopamine D2 and/or D2-like receptors. Dopamine dysregulation, altering signal transmission and leading to psychosis, might stem from interactions between multiple risk factors affecting this pathway (8)(9). Another neurochemical hypothesis is the

glutamate hypothesis. It claims that abnormalities in glutamate synapse formation at specific sites, especially GABA interneurons in the cerebral cortex, lead to excessive glutamate signalling to the ventral tegmental area resulting in excess dopamine in the ventral striatum. Glutamatergic neurotransmission is also connected to NMDA receptor functioning, and NMDA-receptor hypofunction can lead to brain changes that might result in development of psychosis (8)(9). Serotonin (5-HT) hyperactivity of 5-HT_{2A} receptors on glutamate neurons in the cerebral cortex is another pathway associated with hallucinations and delusions. Based on this, the serotonin hypothesis claims overactivation of 5-HT_{2A} receptors on glutamate neurons in the cerebral cortex due to excess serotonin leads to upregulation of the receptors or effects of the receptor's agonists. This then results in the release of glutamate in the VTA which may activate the mesolimbic pathway and cause excess dopamine in the ventral striatum (8)(9). Another hypothesis proposes that increased activation of the endocannabinoid system might result in a hyperdopaminergic and hypoglutamatergic state which may contribute to pathogenesis of schizophrenia. This is supported by evidence that cannabis use in adolescence is a risk factor for developing the disorder (8)(9).

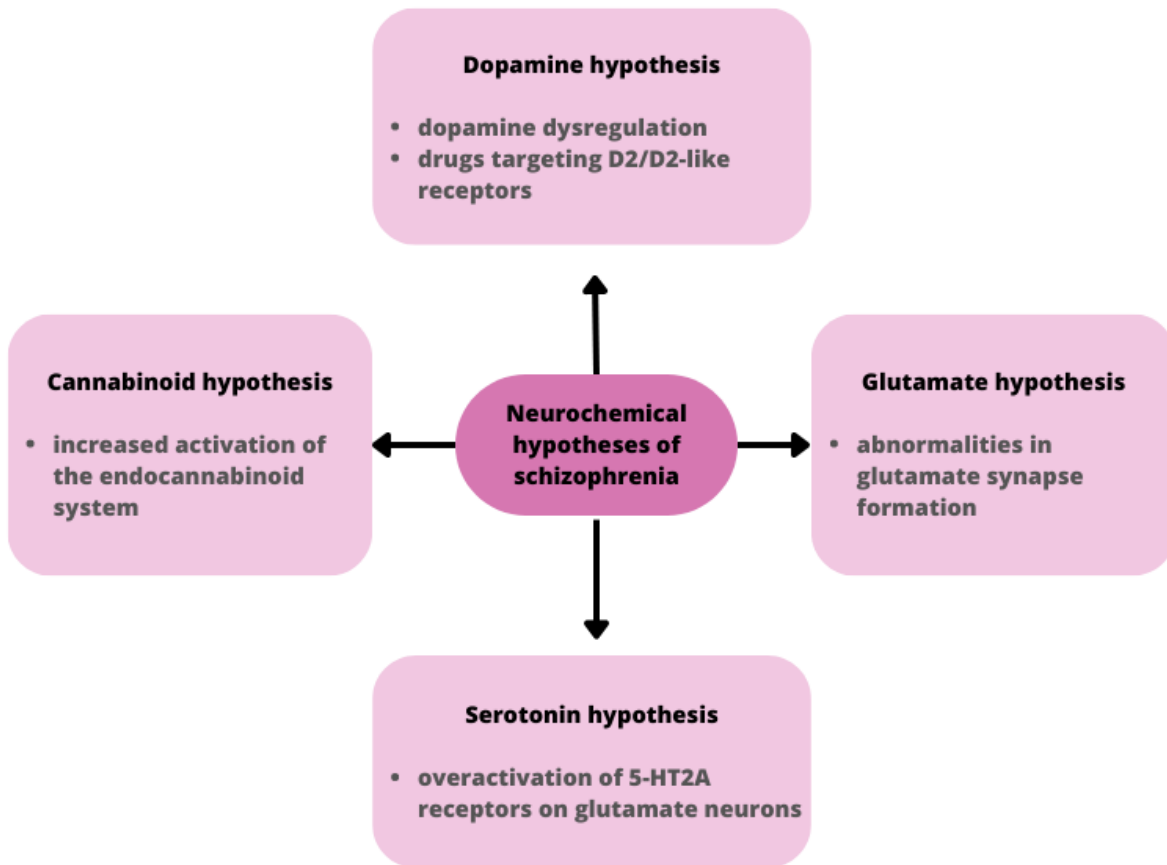

Figure 1. Neurochemical hypotheses of schizophrenia. Neurochemical hypotheses aim to explain the biological pathways underlying the development of schizophrenia.

1.3. Protein aggregation

Translation is a process in which a protein, a sequence of amino acids, is synthesised on a ribosome from a sequence of nucleotides contained in mRNA. In order for that polypeptide to be functional it must be folded correctly into a three-dimensional structure and many undergo modifications such as cleavage or forming covalent bonds with lipids and/or carbohydrates critical for their function and localization in the cell (10). Proteins that catalyse other protein folding by assisting the self-assembly process are

called molecular chaperones. They bind to and stabilise the unfolded or partially folded polypeptide leading it to its correctly folded state. By doing so they prevent incorrect folding or aggregation of proteins and allow the polypeptide chain to fold into the correct conformation (10).

Under the effect of various external and endogenous stresses it is challenging to maintain proteostasis in the cell, which results in the accumulation of misfolded or aggregated proteins due to the disruption of several different mechanisms. The endoplasmic reticulum (ER) regulates protein synthesis, folding and post-translational modifications. It interacts with other organelles in order to regulate proteostasis in the cell and identify disrupted proteins. As a result of stress, which includes disruptions like oxidative stress, lack of nutrition and exposure to adverse physical factors, these processes are altered resulting in accumulation of protein aggregates (11). The ER is connected to mitochondria through the mitochondria-associated membrane (MAM) which is also involved in many cellular processes and protein regulation mechanisms, so impaired mitochondrial function also affects misfolding and aggregating of proteins (11). Closely related to the ER, chaperone proteins supervise the formation of functional proteins after their release from the ER. This process can be disrupted by oxidative stress, inflammation or changes in the ionic calcium levels, and as a result incorrectly folded protein accumulates in the lumen of the ER (11). Another way protein aggregates might accumulate in a cell is the disruption of the autophagy processes. Autophagy is a process which restores homeostasis by degrading damaged proteins that occur naturally in the cell. When autophagy is disrupted the cell starts accumulating damaged proteins which leads to the disruption of various cell activities and toxicity (11).

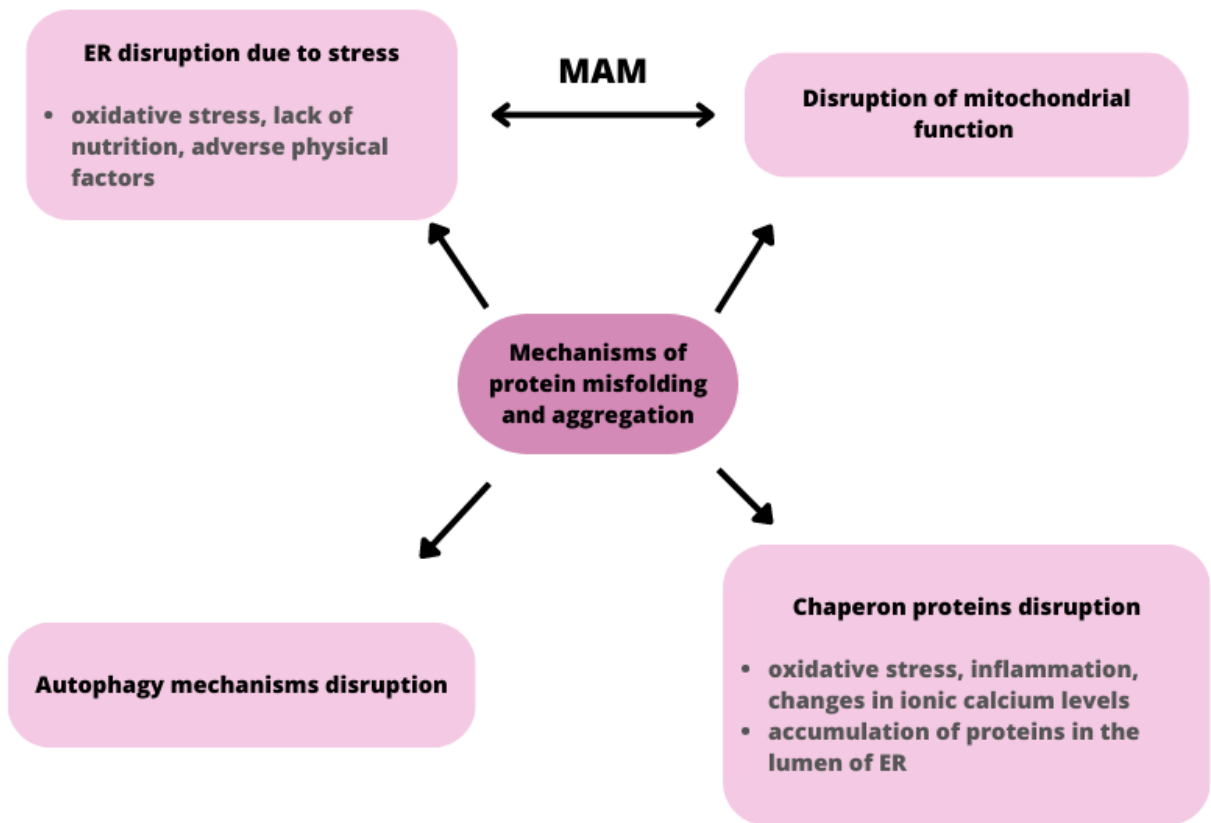

Figure 2. Mechanisms of protein misfolding and aggregation. Under the effects of endogenous and external stresses cellular mechanisms get disrupted, resulting in protein misfolding and the accumulation of protein aggregates. MAM – mitochondria-associated membrane

Almost all kinds of proteins can form aggregates. They are mostly formed by most abundant proteins which contain intrinsically disordered protein regions (IDPRs), segments that are not likely to form defined 3D structures. Because they contain IDPRs, most abundant proteins tend to preform liquid-liquid phase separation and turn into aggregates when facing a persistent stress environment. Besides most abundant proteins, aggregates contain other matter, such as nucleic acids and membrane-less organelles (such as nucleolus, stress granules, P-bodies) (12).

Accumulation of protein aggregates disrupts many of the cell's mechanism and accelerates cell aging. One of the ways protein aggregates harm cells is the interference with lysosomal function by damaging their structure and disturbing lysosomal-associated gene expression which indirectly reduces their degradation capacity (12). Aggregates can also disrupt the protein synthesis environment by inducing ER stress and compromise the ER's protein folding capacity leading to protein misfolding and aggregation. Induction of DNA damage is another way protein aggregates disrupt cell homeostasis. This happens by aggregates touching DNA and destroying its structure, interfering with the DNA repair system, and injuring DNA indirectly by mediums such as ROS. This is the reason why cell aging is a result of protein aggregation (12). Protein aggregates can also disrupt the balance of calcium exchange which causes disorder in biochemical metabolism. They disrupt the membrane system by rupturing it or emulsifying lipid bilayers and trigger ROS production which can then target and attack any substance in the cell (12).

Since protein aggregates interfere with normal functioning of cells, organisms developed ways to protect themselves from them. There are four main pathways for eliminating protein aggregates in the cell. The first choice is refolding and depolymerizing the aggregates. This is usually done by the heat shock protein family, a type of molecular chaperone, which gather protein aggregates and separate them into smaller aggregates (12). The key system for controlling proteostasis in a cell is the ubiquitin-proteasome pathway (UPP), which degrades soluble misfolded proteins and aggregates, or the autophagy-lysosome pathway (ALP), which deals with insoluble ones. In order to be identified by the UPP or ALP and eventually digested, aggregates must be marked by ubiquitin which is accomplished by a hierarchically acting enzymatic cascade (12). Asymmetric cell division is another way of reducing protein aggregates. This way a healthier daughter

cell can be created at the cost of cost of another daughter cell containing more protein aggregates. This way of disposing of aggregates is only possible for dividing cells, so it is another reason why neuronal cells are especially sensitive to protein aggregation (12). Another way of discarding protein aggregates is secreting them by a process similar to mitosis called exocytosis, in which aggregates are secreted in exospheres, membrane-surrounded vesicles that will later be cleared by macrophages (12).

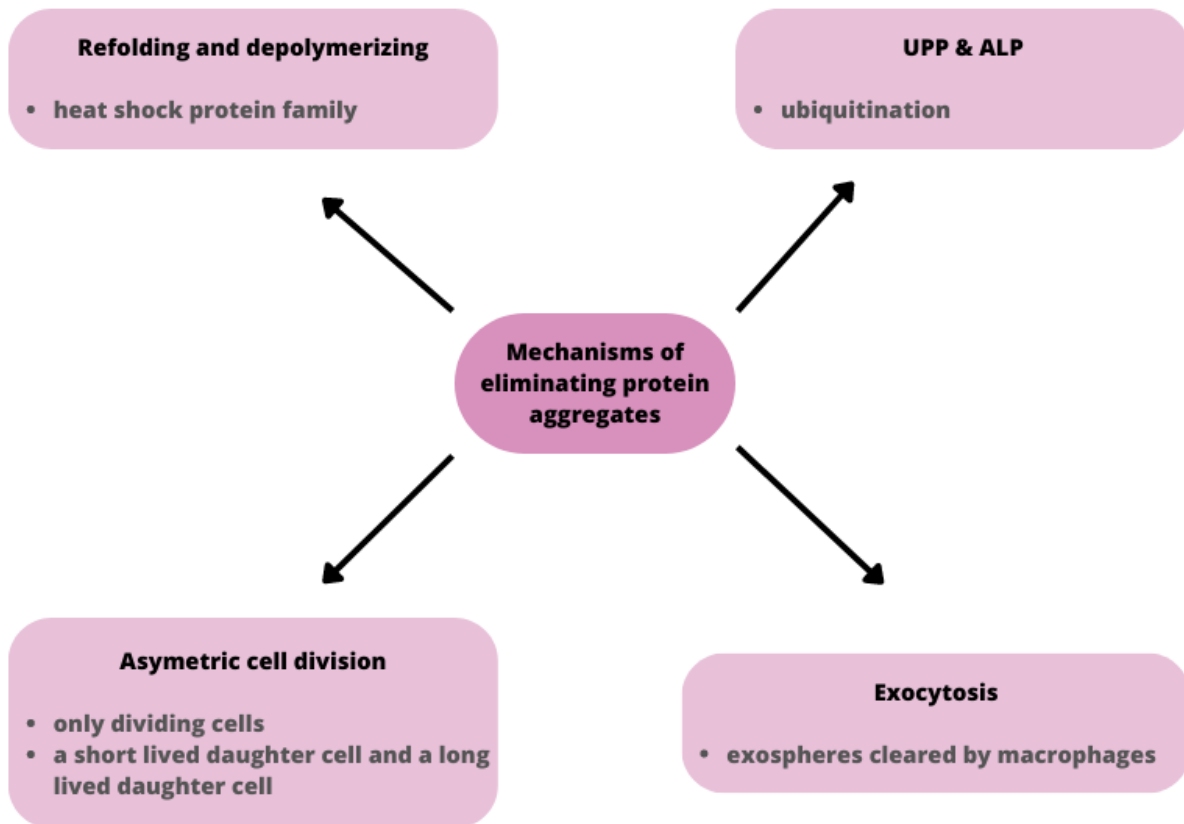

Figure 3. Mechanisms of eliminating protein aggregates in the cell. Cells developed mechanisms of eliminating protein aggregates to avoid the disruptions of cell mechanism they cause. UPP - ubiquitin-proteasome pathway, ALP - autophagy-lysosome pathway.

Protein aggregates have been connected to many diseases, most notably neurodegenerative diseases such as Alzheimer's disease, Parkinson's disease, or Huntington's disease. These diseases occur as a result of accumulating different kinds of protein aggregates in different locations in the brain which leads to dysfunction, atrophy or even apoptosis in those parts and presents as a range of neural symptoms. Some of the proteins most researched in relation with neurodegenerative diseases include amyloid, tau and α -synuclein proteins (12). In the case of mental illnesses, no protein has yet been associated with such a significant role in the development of a disorder. Nevertheless, many proteins have demonstrated the possibility of aggregating in the brains of people suffering from mental illnesses, indicating that their aggregation might be significant in the development of these disorders. In the case of schizophrenia, proteins that have been found to significantly aggregate in patients brains are DISC1, NPAS3, TRIOBP, CRMP1, and dysbindin-1(13)(14)(15)(16)(17). Another protein whose aggregates have been found in schizophrenia brain samples and has shown the possibility of aggregation in human neuroblastoma cells is the Eps15 homology domain-containing protein 3 (EHD3). This was discovered through mass spectroscopy analysis of the brains of patients and controls. (18).

1.4. Eps15 homology domain-containing protein 3 (EHD3)

EHD3 is a part of the C-terminal Eps15 homology domain (EHD) protein family, which includes EHD1-4. These proteins are hetero/homodimeric ATPases that are involved in the regulation of different endocytic transport steps (19)(20). Although they share a high level of amino acid identity (70-86%) proteins in the EHD family have distinct cellular localization and functions and interact with different binding partners. Even EHD1 and EHD3, which share the most amino acid identity (86%) show different functions in

molecular mechanisms. The characteristic component of the EHD protein family is the C-terminal Eps-15 homology (EH) domain with a positively charged surface which allows it to bind to proteins (19).

EHD3 is located on the 2p22-23 human chromosome and is expressed in the brain, liver and kidney (20)(21). Like other EHD proteins, it contains an N-terminal helical region which is followed by an ATP-binding motif also called a G-domain, a central helical domain involved in oligomerisation, a linker region, and the EH domain on the C-terminus (22). The EH domain is made up of a highly conserved stretch of ~100 amino acids. Structurally, it contains two EF-hands (calcium-binding helix-loop-helix) and a short antiparallel β -sheet (20). Functionally, the EH domain specializes in protein interactions by binding tripeptide asparagine-proline-phenylalanine (NPF) residues to the conserved hydrophobic pocket within the domain (20)(21).

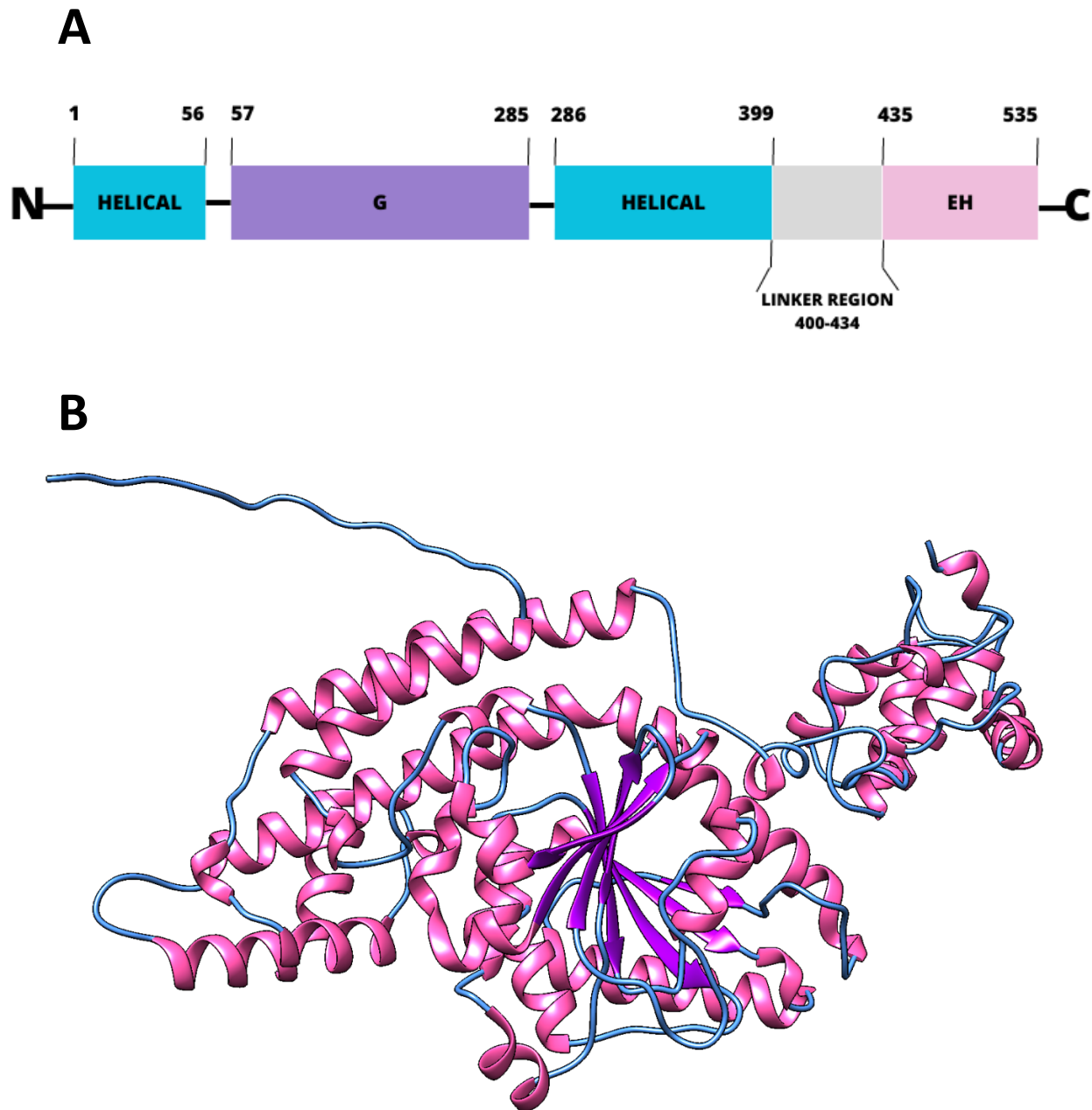

Figure 4. EHD3 protein structure (4A – schematic representation; 4B – 3D structure. EHD3 is consisted of a N-terminal domain, two helical domains, a G domain which binds ATP, a linker region and the EH domain connected to the C-terminal domain. Three-dimensional structure obtained from Alphafold (AF-Q9NZN3-F1) and analysed in Chimera (4B) (23)(24)(25).

The EHD protein family has a role in bending and fission of tubular recycling endosomes (TRE), which is a network of dynamic lipid membranes that coordinate endocytic recycling in mammalian cells. Endocytic recycling is a process of returning internalised receptors to the plasma membrane in order to take part in additional rounds of internalisation. This process is essential for many processes that take place in the cell, including nutrient uptake and regulating surface receptors, ion channels or adhesion molecules. More specifically, EHD3 supports TRE biogenesis and/or stabilization but the exact mechanism of this is as yet unknown (19). EHD3 is localized around endocytic vesicles and tubular structures in the cell, and interacts with EHD1, which is involved in regulating the transport and recycling of receptors. This interaction indicates that EHD3 is involved in the regulation of early-endosome-to-recycling-endosome transport of recycling endocytic vesicles along tubular tracks (21). EHD3 is also involved in the regulation of endosome-to-Golgi transport, most likely in the recruitment process, since EHD3 has the ability to bind proteins and lipids directly. This pathway enables an important group of intracellular sorting receptors and extracellular toxins to be transported from endosomes to the Golgi apparatus and is also critical for the internalization of some bacterial toxins. It has also been shown that in the absence of EHD3, Golgi morphology is drastically altered (26). Alongside EHD1, EHD3 functions in early ciliogenesis. They are involved in the formation of ciliary vesicles and their function affects mother centriole reorganisation (27).

Endocytosis has been shown to promote rapid dopaminergic signalling whose primary mediators are the D1 dopamine receptors. Since EHD3 plays a significant role in endocytosis, by internalizing D1 receptors, it affects dopaminergic transmission. The disruption of dopaminergic signalling has been connected to many pathological conditions, including schizophrenia. This is particularly interesting considering the fact that EHD3 has shown

differential expression and the tendency to aggregate in brain samples of schizophrenia patients (28)(29)(18).

Besides the ability of EHD3 to form aggregates in human neuroblastoma cells, recent research has shown that the aggregates are mostly localized around the nucleus in the cytoplasm of the cell. EHD3 was also co-expressed with other proteins that have also exhibited the possibility of aggregation in schizophrenia brain samples, TRIOBP-1 and dysbindin-1 (30). It has been shown that EHD3 does not co-aggregate with these proteins (31). It has been attempted to determine a region critical for aggregation of EHD3 and although it seemed it was the linker region that was crucial for aggregation (32), further research showed that it is the EH region that is responsible instead (31). It has also been shown that different EHD3 fragments might co-aggregate, with aggregating EHD3 fragments altering the expression of independently non-aggregating EHD3 plasmid fragments when co-expressed in neuroblastoma cells. This indicates that the fragments interact with one another, but the exact mechanism remains unknown (31).

2. Aims of the thesis

It has been found that the EHD3 protein forms aggregates in the brains of patients suffering from schizophrenia. The EH domain is known to be required for the aggregation of the protein, but it is not yet known if it is sufficient for the aggregation alone. It is also not yet known whether the EH domain interacts with the helical or G domains of the protein to cause aggregation. A better understanding of these aspects of EHD3 behaviour would allow us to better understand the mechanism of EHD3 aggregation and lead to new findings about the pathophysiology of schizophrenia. Therefore we will test the hypothesis that the EH domain alone is sufficient for aggregation, and that it can co-aggregate with full length EHD3.

In this thesis we aimed to:

1. Replicate and confirm previous results: aggregation of full length EHD3 and EHD3 amino acids 1-434 as well as non-aggregation of EHD3 amino acids 1-399 and EHD3 amino acids 400-535.
2. Clone new fragments of EHD3 containing just the EHD domain (EHD3 435-535) and express them in neuroblastoma cells to determine whether they can aggregate in isolation.
3. Co-express EHD3 435-535 with full length EHD3, EHD3 1-399 and EHD3 1-434 to observe if and how the expression pattern of the non-aggregating fragment will be altered when co-expressed with aggregating EHD3 plasmid fragments.

3. Methods and materials

3.1. Size markers

- My-Budget 1kb DNA Ladder - Bio Budget Technologies GmbH
Contains 13 blunt-ended fragments in the range from 250 bp (base pairs) to 10 kbp (kilobase pairs). Used for gel electrophoresis.
- My-Budget Prestained Protein Ladder 10-180 kDa -Bio Budget Technologies GmbH
Contains proteins with size ranges between 10kDa-180kDa. Used for Western Blots.

3.2. Antibodies and fluorescent markers

Table 1. Fluorescent markers and primary and secondary antibodies used for Western blotting and immunocytochemistry.

Name	Supplier	Concentration	Dilution	Type
Anti-Flag M2 – Monoclonal (Mouse)*1	Sigma	1 mg/mL	1:2000	Primary antibody
Anti-GFP – Monoclonal (Mouse)*	Sigma	1 mg/mL	1:2000	Primary antibody
Peroxidase Conjugated Affinity Purified Goat anti-Mouse igG	Thermo Fisher Scientific	1 mg/mL	1:2000	Secondary antibody

Alexa Fluor 555 Goat anti-Mouse IgG	Thermo Fisher Scientific	2 mg/mL	1:1000	Secondary antibody
DAPI	Sigma	1 mg/mL	1:500	Fluorescent marker

3.3. Plasmids and vectors

Table 2. List of plasmids

Vector	Encoded protein	Source
pdcdNA-Flag	EHD3 full length	University of Rijeka
pdcdNA-Flag	EHD3 (1-399 amino acids)	University of Rijeka
pdcdNA-Flag	EHD3 (1-434 amino acids)	University of Rijeka
pdcdNA-Flag	EHD3 (400-535 amino acids)	University of Rijeka
pdcdNA-Flag	EHD3 (435-535 amino acids)	University of Rijeka
pDEST-CMV-N-EGFP	EHD3 full length	University of Rijeka
pDEST-CMV-N-EGFP	EHD3 (1-399 amino acids)	University of Rijeka
pDEST-CMV-N-EGFP	EHD3 (1-434 amino acids)	Novel to this thesis
pDEST-CMV-N-EGFP	EHD3 (435-535 amino acids)	Novel to this thesis

pDEST-CMV-N-EGFP	empty	Robin Ketteler, University College London, UK
pETNR1A	EHD3 (1-434 amino acids)	University of Rijeka
pENTR1A	EHD3 (435-535 amino acids)	University of Rijeka

3.4. Bacterial transformation

In an Eppendorf tube 50 μ L of NEB5- α bacterial cells and 1 μ L of plasmid were mixed and the solution then incubated on ice for 30 minutes. After incubation, bacteria were heat shocked at 42°C for exactly 30 seconds after which, the Eppendorf tubes were immediately placed back on ice for another 5 minutes. When transforming kanamycin resistant plasmids or newly generated expression vectors an additional step of adding 250 μ L of LB media (10 g tryptone, 5 g yeast extract, 5 g NaCl, dH₂O added up to 1 L, pH 7.0) into the Eppendorf tube and incubating the mixture in an incubator at 37°C and 250 rpm was performed. Transformed bacteria were plated on LB agar (1 g tryptone, 0.5 g yeast extract, 0.5 g NaCl, 1.5 g Agar, dH₂O added up to 100 mL) plates containing appropriate antibiotics and incubated at 37°C overnight.

3.5. Bacterial liquid culture and plasmid DNA purification

After overnight incubation, a single colony from the bacterial plate was transferred into a Falcon tube containing 3 mL of LB media and 3 μ L of the appropriate antibiotic. The Falcon tube was then left incubating at 37°C and 250 rpm overnight.

The next day cultures were centrifuged for 15 minutes and 4°C at 13000 rpm. The supernatant was discarded and the pellet containing bacterial cells was used for plasmid DNA purification which was done using a commercially available kit called QIAprep Spin Miniprep Kit. The bacterial pellet was resuspended in 250 µl of buffer P1 and transferred to an Eppendorf tube. Next, 250 µl of buffer P2 was added and the suspension turned blue as the cells were lysed. Immediately, 350 µl of buffer N3 was added to stop the reaction and the suspension turned milky white. The suspension was then centrifuged for 10 minutes at 13000 rpm. The supernatant was transferred to a QIAprep 2.0 spin column and centrifuged for 60 seconds at 13000 rpm while the pellet was discarded. The column was then washed with 750 µL of buffer PE and centrifuged again for 60 seconds at 13000 rpm. After discarding the flow through, the column was centrifuged one more time for 60 seconds at 13000 rpm. The flow through was again discarded and the column was transferred to an Eppendorf tube and washed using 50 µL of previously warmed up TE/EB buffer (0.5 mL 1 M Tris pH 7.4, 200 µL 0.25 M EDTA, dH₂O added up to 50 mL) to elute the DNA. After incubation for 1 minute the tubes were centrifuged for the final time for 60 seconds at 13000 rpm.

3.6. Measuring DNA concentrations

The concentration of plasmid DNA acquired by bacterial transformation and plasmid DNA purification was determined using a BioDrop µLITE spectrophotometer with the absorbance wavelength set to µLite 0.5 mm. TE/EB buffer was used as a blank probe. 1 µl of the sample was used for measuring and the determined concentration was expressed as ng/mL.

3.7. LR clonase reaction

To create new expression vectors, 100 ng of an entry vector, 150 ng of a destination vector, 1 μL of LR clonase and the amount of TE/EB buffer needed to reach the total volume of 10 μL were mixed in an Eppendorf tube. The tube was then incubated for 1 hour at 25°C. Following incubation, 1 μL of Proteinase K was added to the tube and incubated for 5 minutes at 37°C. To select for destination vectors that had taken up the gene of interest the plasmids were then transformed as described. Newly prepared expression vectors were sent to be sequenced so they could later be used for transforming bacteria.

3.8. Agarose gel electrophoresis

Agarose gel was prepared by mixing 0.5 grams of agarose, 50 mL of 1x TAE buffer (50x stock solution; 242 g Tris, 18.61 g EDTA, 57.1 mL acetic acid, dH₂O added up to 1L) and 1 μL of Gel Green Stain. The mixture was heated up in the microwave to dissolve the agarose. When cool enough, the gel was poured into the tray and left to solidify. Next the gel was transferred to an electrophoresis tank filled with 1x TAE buffer, and the marker and plasmid samples were loaded on the gel. The plasmid samples consisted of 2 μL of plasmid DNA, 1 μL of Green buffer and 7 μL of dH₂O. The electrophoresis was run for 18 minutes at 140 V and the gel was imaged using the BioRad Chemi-Doc MP Imaging System.

3.9. Cell culture

Two different mammalian cell lines were used for this thesis. HEK293 are a human embryonic kidney cell line characterised by fast proliferation and high transfection rate. This cell line requires DMEM media (500 mL DMEM, 50 mL

FCS (foetal calf serum), 5 mL non-essential amino acids, 5 mL penicillin/streptomycin) for growth and was used for Western blotting and immunocytochemistry. The other cell line that was used for this thesis was the SH-SY5Y human neuroblastoma cell line. It requires DMEM-F12 media (500 mL DMEM, 50 mL FCS, 5 mL 100X non-essential amino acids, 5 mL 1x penicillin/streptomycin) for growth. This cell line is more difficult to sustain and grows more slowly in contrast to HEK293 cells. SH-SY5Y cells were used for immunocytochemistry. Both cell lines are adherent and were grown in T25 cell culture flasks and used when they reached confluency of 80% or higher.

Working with both cell lines in a culture hood requires a sterile environment which was insured by sterilising the surface of the inside of the hood using 70% ethanol, incidin, 70% isopropanol and DNA erase solution. Everything that was placed in the hood was sprayed with 70% ethanol beforehand.

3.9.1. Cell splitting

Once cells reached the wanted confluency, the media was removed from the flask and 1 mL of trypsin was added to break the bonds between the cells and the flask surface. The flask was then incubated for 10 minutes at room temperature after which it was hit firmly a few times to make sure all the cells detached from the surface. 4 mL of the appropriate DMEM media was added to the flask to stop the trypsin reaction and a certain volume of the cells was transferred to a new flask containing fresh media so that the total volume the flask contained was 5 mL. The newly prepared flask was stored in the incubator at 37°C and 5% CO₂ until it was ready to be split again.

When splitting cells for transfections, cells were transferred into plates containing a different number of wells (12 or 24). When splitting HEK293 cells for Western blotting, each well on a 12-well plate contained 270 µL of

cell suspension and 1700 μL of fresh media. When used for immunocytochemistry a glass coverslip was put into each well. When splitting HEK293 cells for immunocytochemistry each well on a 24-well plate contained 40 μL of cell suspension and 500 μL of fresh media. SH-SY5Y cells were split into 24-well plates with each well containing 300 μL of cell suspension and 1 mL of fresh media. Plates were stored in the incubator at 37°C and 5% CO_2 overnight.

3.9.2. Transfecting cells

When transfecting cells, DMEM or DMEM-F12 media (depending on the cell line that was being transfected) without antibiotics or serum was used (-/- media). Depending on the cell line that was transfected, Metafectene was used when working with HEK293 cells while Metafectene PRO was used when working with SH-SY5Y cells. In an Eppendorf tube 100 μL of -/- media and 2 μL of Metafectene or Metafectene PRO per well were mixed. After 5 minutes at room temperature 100 μL of this prepared Metafectene solution was transferred to an Eppendorf tube containing 500 ng of plasmid DNA and 100 μL of -/- media. The Eppendorf tubes were then incubated for 30 minutes in the incubator at 37°C and 5% CO_2 . The media was removed from the wells incubating from the day before and replaced with 500 μL of fresh -/- media. This media was also removed to make sure there were no antibiotics or serum left in the wells. 300 μL of the same media was then added in each well and after the incubation, 200 μL of the plasmid DNA and Metafectene solution was transferred into each corresponding well. The plate was then incubated at 37°C and 5% CO_2 for 6 hours, after which the media was removed and replaced with 1 mL of fresh media containing antibiotics and serum (+/+ media). The plate was then left in the incubator overnight.

3.9.3. Cell lysis

To previously prepared cell lysis buffer (5 mL 10x PBS, 5 mL 10% Triton x-100, 1 mL 1M MgCl₂, 50 µL DNaseI, 50 µL 100 mM Phenylmethyl-sulphonyl fluoride, dH₂O added up to 50 mL) protein inhibitor cocktail (1:50) and DNaseI (1:1000) were added. The media was removed from wells incubating overnight and washed twice using 500 µL of PBS (80 g NaCl, 2 g KCl, 14.4 g Na₂HPO₄, 2.4 g KH₂PO₄, dH₂O up to 1 L, pH 7.4). After removing the PBS, 100 µL of cell lysis buffer solution was added to each well and left on ice for 5 minutes. The lysed cell suspensions were then transferred to corresponding Eppendorf tubes and spun on the rotor for 30 minutes. Prepared samples were stored at -20°C or prepared for Western blotting.

3.10. Western Blot

3.10.1. Preparing acrylamide gels

Based on the sizes of the samples (proteins), different concentrations of running gels were used. Running gels were prepared as described in Table 3. and poured between glass plates leaving 1 cm empty at the top, which was filled with dH₂O, and the gel was left to solidify. When solid, the dH₂O was removed and replaced with a stacking gel (2.6 mL dH₂O, 1mL 30% acrylamide mix, 625 µL 1M Tris pH 6,8, 50 µL 10% SDS, 50 µL 10% APS, 5 µL TEMED). A comb was added in the stacking gel and left to solidify.

Table 3. Chemical volumes used for the preparation of different concentrations of acrylamide gels and the sample sizes they were used for.

	8% gel	10% gel	15% gel	Stacking gel
Sample size (kDa)	>60	30-60	5-15	All samples
dH₂O (mL)	5.5	4.8	3.9	2.6
30% acrylamide (mL)	3.2	3.9	4.8	1
1.5M Tris pH 8,8 (mL)	3	3	3	/
1M Tris pH 6,8 (μL)	/	/	/	625
10% SDS (μL)	120	120	120	50
10% APS (μL)	120	120	120	50
TEMED (μL)	12	12	12	5

3.10.2. SDS-PAGE

100 μL of cell lysates were diluted by adding 100 μL of loading buffer (6.25 mL 1M Tris, 10 mL glycerol, 20 mL 10% SDS, 3.75 mL dH₂O, 5 mg bromophenol blue) and 20 μL of 1M DTT. Next, the samples were heated at 95 °C for 5 minutes and then transferred on ice. Acrylamide gels were placed into the SDS-PAGE tank filled with running buffer (30 g Tris, 144 g glycine, 10 g SDS, dH₂O up to 1 L), combs were removed and 20 μL of samples and 2 μL of the maker were loaded into the wells. The gels were run for 45 minutes at 180 V.

3.10.3. Transferring to membrane

Gels were transferred to plastic trays containing 50 μ L of transfer buffer (5.8 g Tris, 2.9 g glycine, 4 mL 10% SDS, 200 mL methanol, dH₂O up to 1 L) which was then poured out, replaced with the same amount of fresh buffer and left incubating on the shaker for 10 minutes. An 8x6 cm PVDF membrane was cut and activated by washing with methanol. It was then incubated in transfer buffer for 5 minutes. Two 8x6 cm blotting papers were cut, wetted, and placed on the transfer cassette. On top of the paper the membrane was placed face up and covered with the other piece of wet blotting paper. Using a roller, air bubbles were removed and the cassette was locked and placed in the Transblot system. The transfer was run for 30 minutes at 25 V. following the transfer, membranes were put in trays containing dH₂O which was then removed and replaced with fresh dH₂O. The H₂O was replaced with Ponceau S staining solution (1 g Ponceau S, 4 mL acetic acid, dH₂O up to 200 mL) which was poured off after 30 seconds. The membrane was washed with dH₂O until clear, after which they were washed once using PBS-T (50 mL 10x PBS, 450 mL dH₂O, 250 mL Tween 20).

3.10.4. Antibody staining

Membranes were blocked by placing in 50 mL of PBS-T containing 5% milk powder on the shaker for 1 hour. Next the membranes were washed twice using PBS and incubated overnight in 6 mL PBS-T containing 1:2000 anti-FLAG of anti-EGFP primary antibody. The next day, the primary antibody solution was poured off and the membranes were washed 3 times with PBS-T with 10-minute intervals between washes. Then the membranes were incubated on the shaker for 1 hour in diluted (1:1000) secondary GAM (goat-anti-mouse) antibody in 6 mL of PBS-T. After incubation, the secondary antibody was poured off and the membrane was again washed 3

times with PBS-T. Before visualisation by the Bio-Rad ChemiDoc Imaging system, the membranes were covered in ECL visualising agent.

3.11. Immunocytochemistry

3.11.1. Fixation and permeabilisation

SH-SY5Y cells in 24-well plates transfected the day before were washed once using PBS and then fixed by incubating in fixation buffer (8g paraformaldehyde, 20 mL 10x PBS, dH₂O up to 200 mL, pH 7.4). After removing the fixation buffer, permeabilization buffer (10 mL 10x PBS, 500 µL Triton X-100, dH₂O up to 50 mL) was added for 10 minutes. After incubation, the wells were washed 3 times using PBS.

3.11.2. Cell staining

Coverslips were blocked with 10% goat serum/PBS for 45 minutes. After removing the blocking media, 100 µL of primary antibody solution (10% goat serum/PBS, 1:1000 Flag M2) was added and incubated on the shaker for 3 hours. The primary antibody solution was then removed, and the wells were washed 3 times using PBS. Next, 100 µL of the secondary antibody solution (Goat Anti Mouse RED 555 (1:500), DAPI (1:500), 10% goat serum/PBS) was applied for 1 hour in the dark after which the cells were washed again using PBS 3 times and once using milliQH₂O. Coverslips were then attached to microscopy slides using commercial mounting medium and stored in the fridge. Samples were visualised using Olympus IX83 fluorescent microscope with CellSens software.

4. Results

4.1. Verifying EHD3 fragments by Western blotting

Western blotting was done in order to confirm that each transformed plasmid produces protein of the expected size. Detecting the proteins of interest was done by using specific antibodies. Depending if the proteins contained a FLAG tag or EGFP tag anti-FLAG primary antibody was used to detect the former type of proteins while anti-GFP primary antibody was used for identifying those containing the EGFP tag. GAM secondary antibody was used for detection of all proteins. Depending on their expected size, the plasmids were run on an acrylamide gel of appropriate concentration. Full length EHD3 with the EGFP tag was run on 8% acrylamide gel. Full length EHD3, EHD3 amino acids 1-399 and EHD3 amino acids 1-434 containing the FLAG tag were run on 10% gel. EGFP control, EHD3 amino acids 435-535 containing the EGFP tag, EHD3 amino acids 400-535 and EHD3 amino acids 435-535 with FLAG tags were all run on 15% acrylamide gels. The structures of EHD3 plasmid fragments are seen in figure 5. After transforming, plasmids were expressed in the HEK293 cell line. The cells were then lysed and prepared for Western blotting. After visualising membranes using the ECL Prime Kit and ChemiDoc system, all plasmids were confirmed to function as expected, producing proteins of expected size.

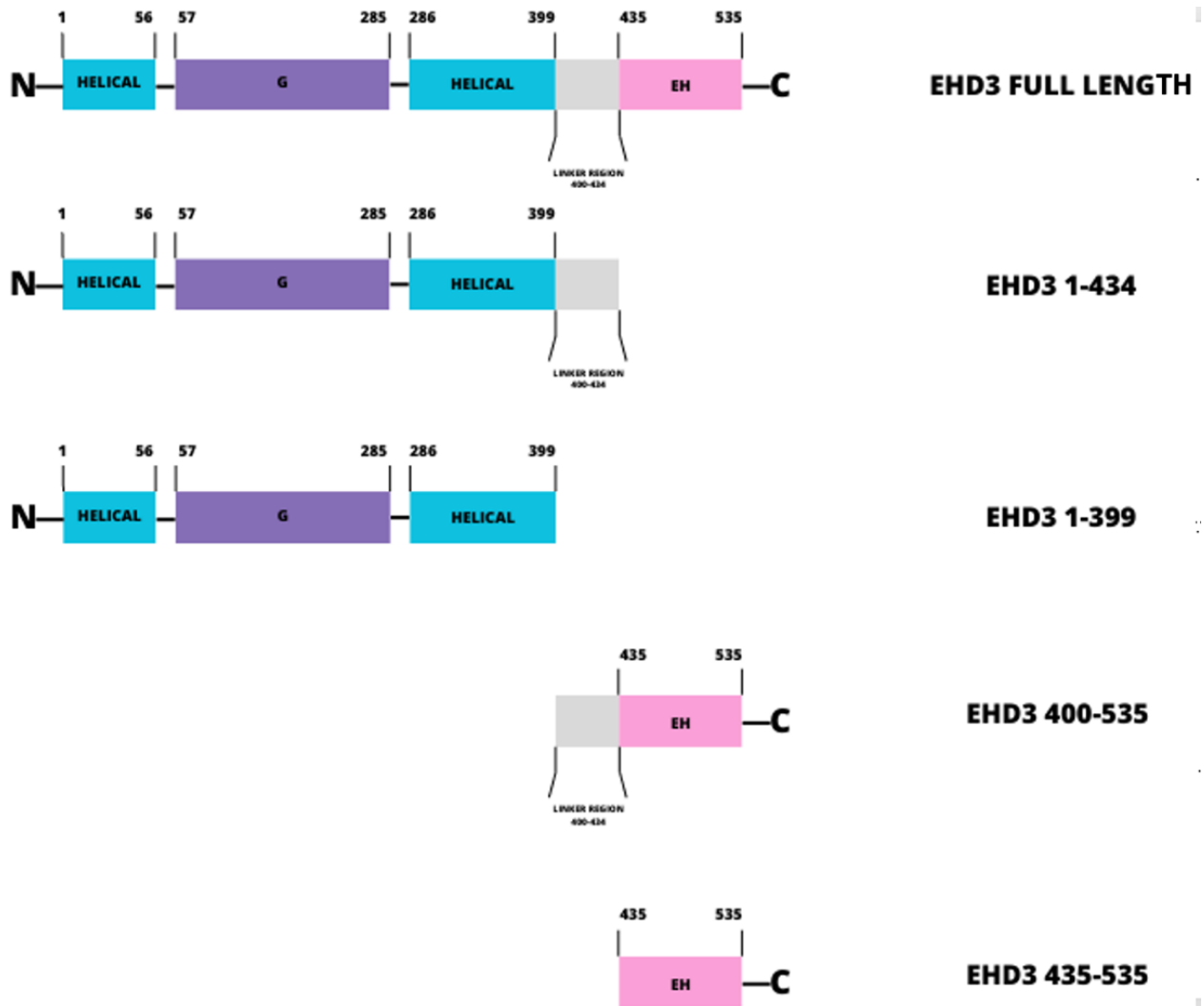

Figure 5. Structures of EHD3 fragments used for this thesis. Numbers represent the amino acids in proteins structure.

Expected sizes of EHD3 1-399 (48 kDa) and EHD3 1-434 (52 kDa) with FLAG tags corresponded with the specific bands that were visible on the membranes (Figure 6A). Specific bands of other FLAG tag containing plasmids did not exactly correspond with their calculated sizes. Full length EHD3 (64 kDa) (Figure 6A), EHD3 435-535 (12) and EHD3 400-535 (16) (Figure 6B) showed bands higher on the gel than was expected. This could be due to their post translational modifications in the cell which include processes such as phosphorylation and glycosylation. The differences in

expected and visualised sizes were not significantly big so plasmids were confirmed as functional. Mock transfected control samples did not show any bands.

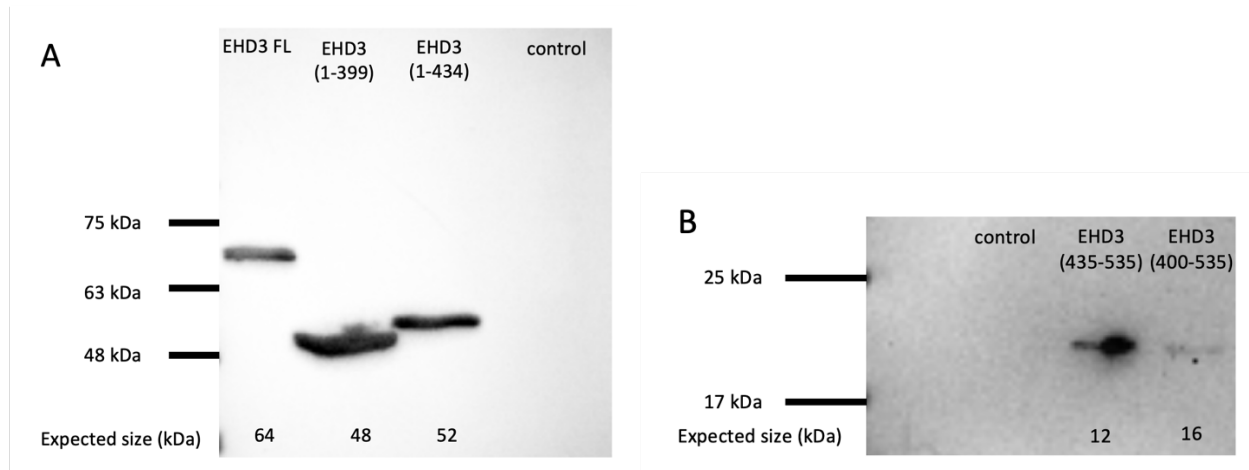

Figure 6. Western blots of EHD3 plasmid fragments containing the FLAG tag. Plasmids were detected using anti-FLAG primary antibody and GAM secondary antibody. Control samples are mock transfected HEK293 cells. Protein sizes are compared to Prestained Protein Ladder 10-180 kDa.

When calculating the expected sizes of EHD3 plasmid fragments containing the EGFP tag, the size of the tag (30 kDa) was added to the expected size of the fragment itself. Full length EHD3 (94 kDa) (Figure 7B), EHD3 435-535 (39 kDa) (Figure 7A) and EHD3 1-399 (78 kDa) (Figure 7C) showed bands corresponding to their expected calculated sizes. The band of EGFP control (30kDa) was slightly higher on the gel than expected (Figure 7A), which can also be explained by post translational modification of the protein in the cell, but the plasmid was confirmed as functional. The control samples also did not exhibit any bands on the membrane.

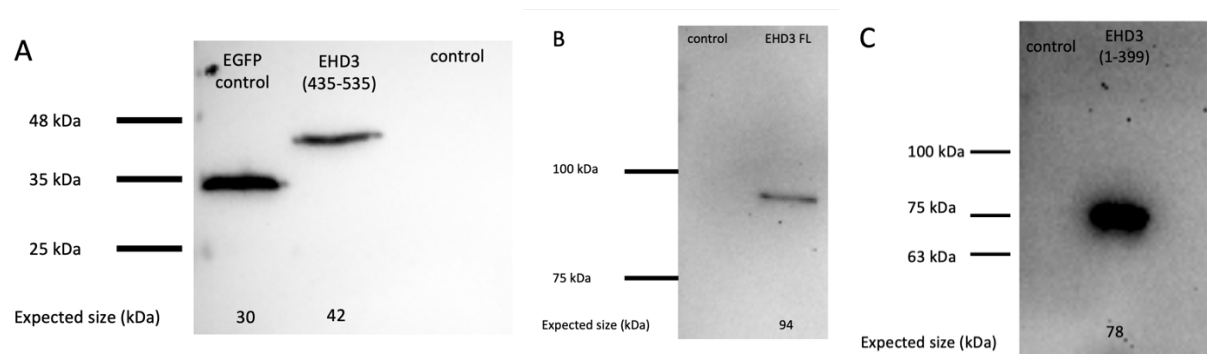

Figure 7. Western blots of EHD3 plasmid fragments containing the EGFP tag. Plasmids were detected using anti-GFP primary antibody and GAM secondary antibody. Control samples are mock transfected HEK293 cells. Protein sizes are compared to Prestained Protein Ladder 10-180 kDa.

4.2. Expressing EHD3 fragments in SH-SY5Y cell line and HEK293 cell line by fluorescent microscopy

Immunocytochemistry was used in order to replicate and confirm results from previous research by expressing EHD3 fragments in SH-SY5Y and HEK293 cells. It was also used for expressing novel EHD3 fragments in SH-SY5Y cells. The different cell lines were used to ensure the results were not affected by using different cell lines. In both cell lines plasmids were transfected and later stained using anti-FLAG or anti-GFP primary antibody and GAM 555 secondary antibody. FLAG tag emits red fluorescent signals and EGFP tag emits green fluorescent light under the microscope. Nucleuses were stained blue using DAPI dye.

4.2.1. Replicating and confirming results from previous research

In order to ensure all plasmids were functioning and behaving as expected in the cell we attempted to replicate the results obtained in previous research.

We expressed them in both SH-SY5Y and HEK293 cell lines to ensure the cell line did not affect the results of the experiment.

4.2.2. Expressing EHD3 plasmids in HEK293 cell line by fluorescent microscopy

As seen in Figure 8., full length EHD3 protein forms aggregates in the cytoplasm of the cell when fused to both FLAG and EGFP tags, as expected. EHD3 1-399 does not clearly aggregate when fused to FLAG tags, it rather forms filamentous structures visualised as red strands in the cytoplasm. However, when fused to the EGFP tag EHD3 1-399 does form aggregates in the cytoplasm of the cell. Due to its size (30 kDa), the EGFP tag makes the protein more prone to aggregation. EHD3 1-434 fused to the FLAG tag also seems to aggregate but from previous research it is known that it rather forms clusters resembling aggregates located in the cytoplasm of the cell. This is based on the fact that while full length EHD3 was shown to be consistently insoluble, EHD3 1-434 was consistently soluble when analyzed in the ultracentrifugation assay. All of the observed results are consistent with the results obtained in previous research observing full length EHD3, EHD3 1-399 and EHD3 1-434 in HEK293 cells. (31)(32).

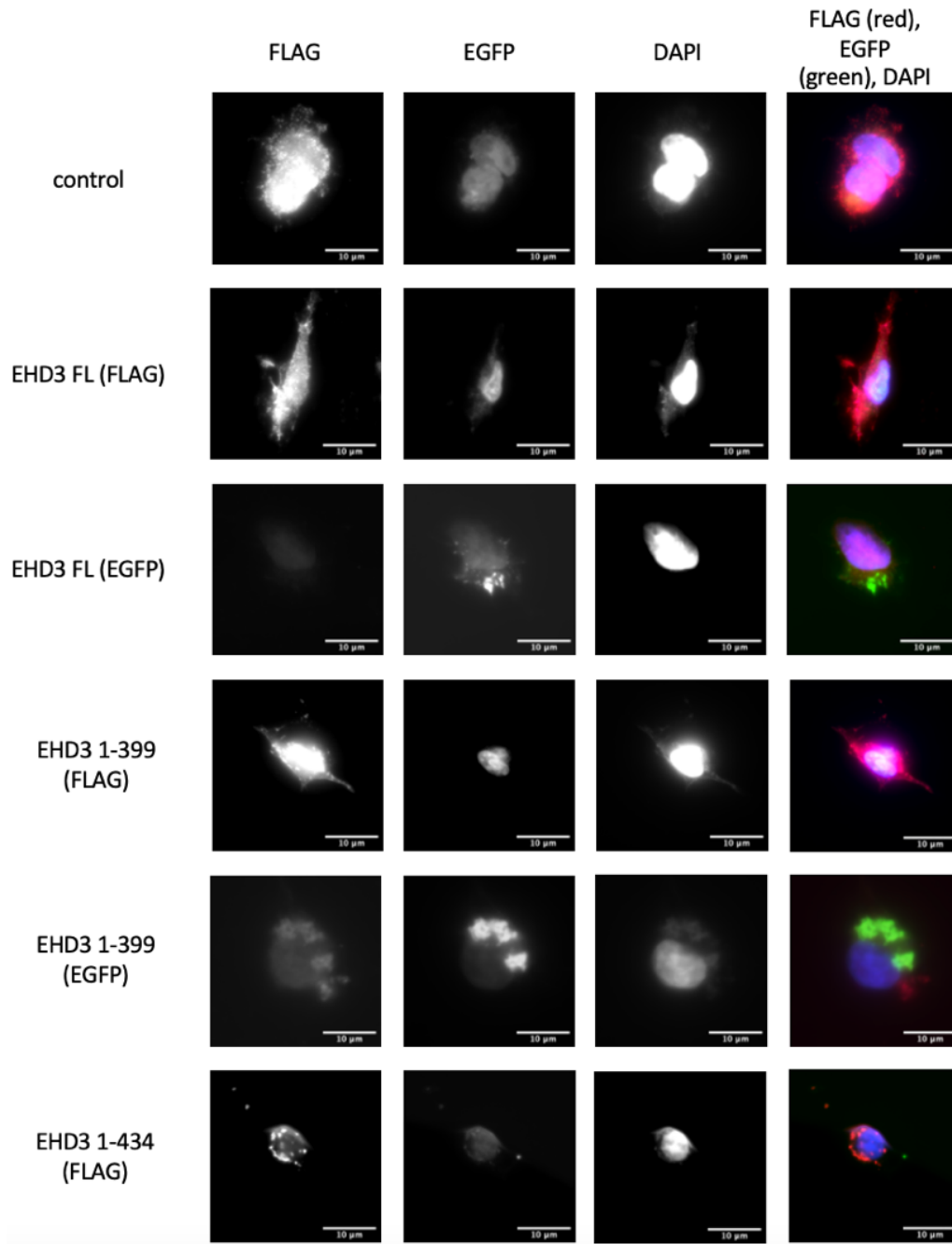

Figure 8. EHD3 FL aggregates, EHD3 1-434 forms aggregate-like clusters, and EHD3 1-399 does not aggregate in HEK293 cell line. Proteins were stained using anti-FLAG (red signal) or anti-GFP (green signal) primary antibody and GAM 555 secondary antibody. Nucleuses were stained blue using DAPI. Images were obtained by 60X magnification using fluorescent microscope and Cell Sens software. The scale bar corresponds to 10 μ m. Control sample represents mock transfected HEK293 cells.

4.2.3. Expressing EHD3 plasmids in SH-SY5Y cell line by fluorescent microscopy

When expressed in the SH-SY5Y cell line, full length EHD3 clearly aggregates, forming clusters located in the cytoplasm of the cell. The tag fused to the protein, FLAG or EGFP does not affect the aggregation. EHD3 1-399 fused with the FLAG tag aggregates more when expressed in SH-SY5Y cells but is still more expressed in filamentous structures throughout the cytoplasm. When fused to the EGFP tag, EHD3 1-399 looks like it aggregates, with the aggregates in the cytoplasm of the cell. EHD3 1-434 fused to the FLAG tag also seemingly aggregates greatly, forming large clusters of the protein. They are distributed all over the cytoplasm, while the protein aggregates expressed in HEK293 cells were located mainly around the nucleus. Previous research confirmed these clusters are not in fact aggregates as they are not insoluble, unlike the full length EHD3. EHD3 400-535 fused to the FLAG tag does not clearly aggregate. Similarly to full length EHD3 fused to the FLAG tag, it is expressed as filamentous structures that are located both in the cytoplasm of the cell, as well as the nucleus (Figure 9). All protein fragments that have been expressed in both SH-SY5Y cells and HEK293 cells, except EHD3 1-399 fused to the FLAG tag, exhibit the same expression pattern in both used cell lines. The obtained results agree with the results of previous research (31)(32).

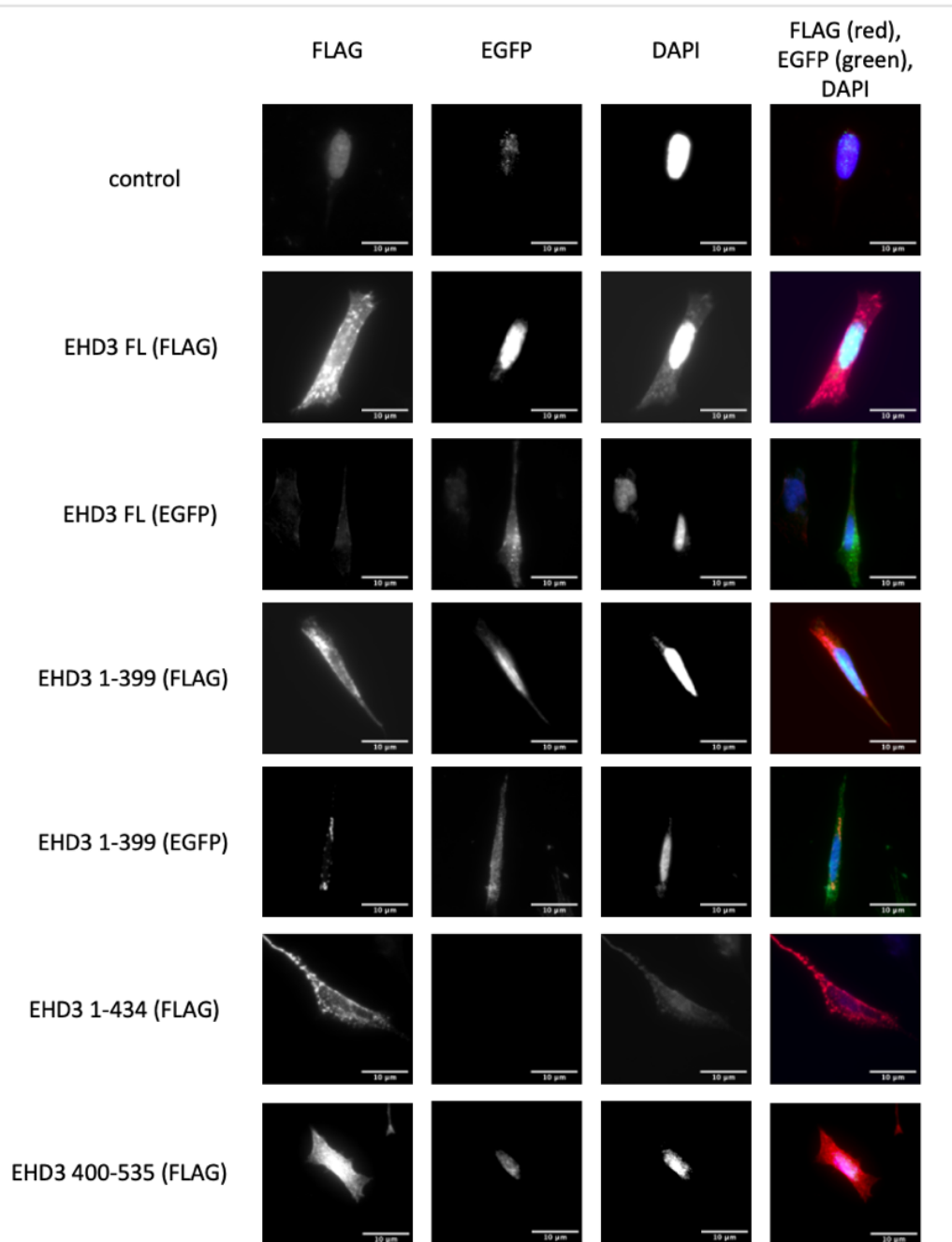

Figure 9. EHD3 FL and EHD3 1-399 aggregate, EHD3 1-434 forms aggregate-like clusters, and EHD3 400-535 does not aggregate in SH-SY5Y cell line. Proteins were stained using anti-FLAG (red signal) or anti-GFP (green signal) primary antibody and GAM 555 secondary antibody. Nucleuses were stained blue using DAPI. Images were obtained by 60X magnification using fluorescent microscope and Cell Sens software. The scale bar corresponds to 10 μ m. Control sample represents mock transfected SH-SY5Y cells.

4.3. Expressing novel EHD3 fragments in SH-SY5Y cell line by fluorescent microscopy

In order to further investigate the way EHD3 fragments containing different structural regions behave, novel EHD3 plasmid fragments were cloned and expressed in the SH-SY5Y cell line.

The EHD3 435-535 plasmid fragment containing a FLAG tag was previously cloned (32), but has not yet been expressed in any cell line. This plasmid contains just the EH domain linked to the C terminal domain (Figure 5). When expressed in SH-SY5Y cells it showed no clear signs of aggregation. It was expressed uniformly across the cytoplasm and nucleus of the cell in filamentous structures (Figure 10). EHD3 1-434 bound to the EGFP tag and EHD3 435-535 containing an EGFP tag were newly cloned and expressed in SH-SY5Y cells. As with the plasmid containing the FLAG tag, EHD3 435-535 fused to the EGFP tag contains only the EH domain and does not form aggregates when expressed in SH-SY5Y cells. EHD3 1-434 contains both helical regions, the ATP-binding domain, and the linker region of the protein, but does not include the EH domain (Figure 5). It forms aggregate-like clusters greatly in SH-SY5Y cells, forming large clumps of protein in the cytoplasm and the nucleus of the cell, the same as the EHD3 1-434 containing the FLAG tag (Figure 10).

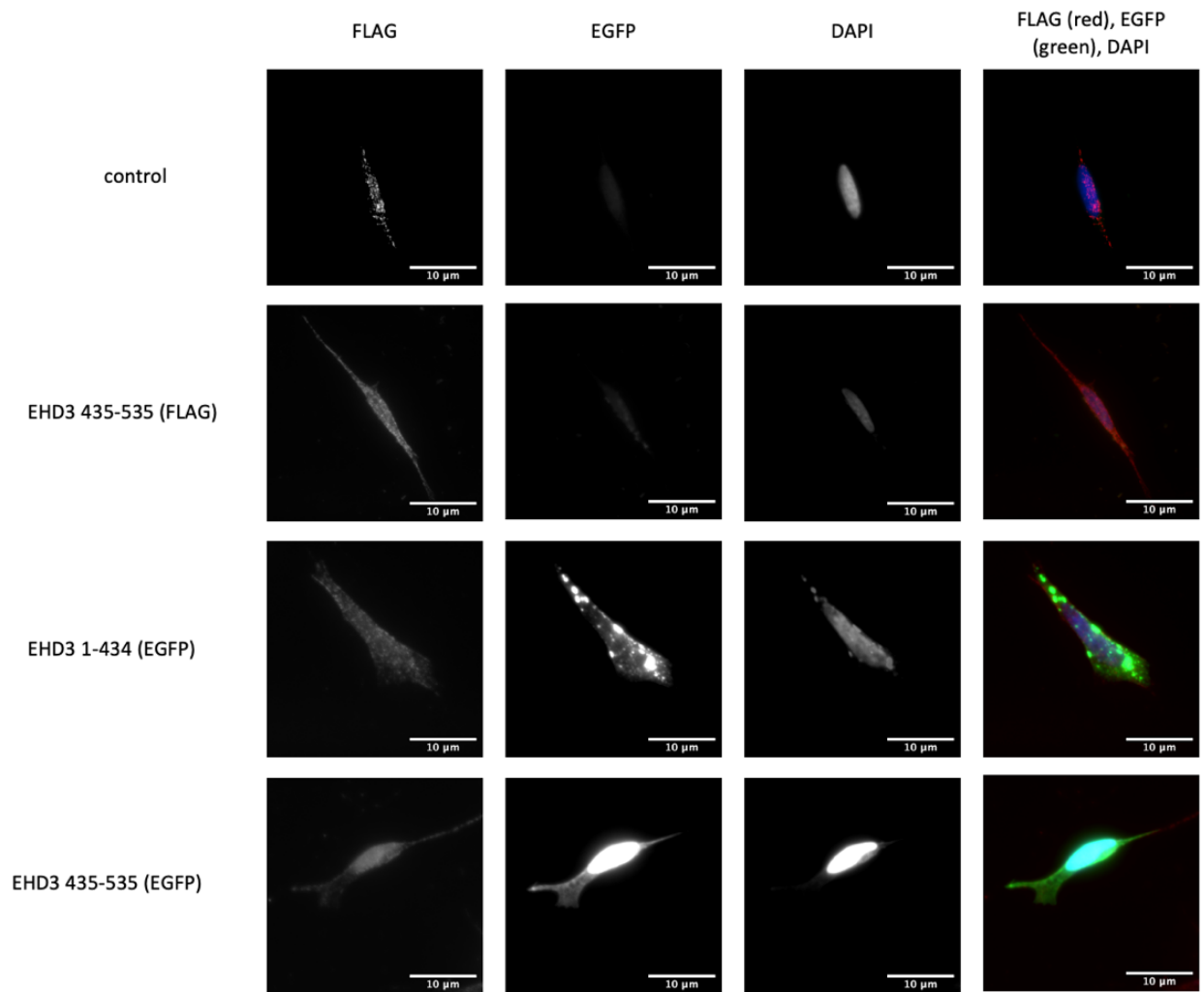

Figure 10. EHD3 435-535 and EHD3 1-434 do not aggregate, but EHD3 1-434 forms aggregate-like clusters in SH-SY5Y cells. Proteins were stained using anti-FLAG (red signal) or anti-GFP (green signal) primary antibody and GAM 555 secondary antibody. Nucleuses were stained blue using DAPI. Images were obtained by 60X magnification using fluorescent microscope and Cell Sens software. The scale bar corresponds to 10 μm . Control sample represents mock transfected SH-SY5Y cells, while EGFP control represents the expression of EGFP tag in SH-SY5Y cells.

4.4. Aggregating EHD3 fragments do not induce the aggregation of non-aggregating EHD3 435-535

Aggregates are known to spread among cells, with one aggregating molecule causing other molecules around it to become prone to aggregation as well. By doing so, aggregation of proteins is amplified among cells. To examine if the same can happen with the EHD3 protein, a EHD3 plasmid fragment that has been shown not to aggregate was co-expressed with aggregating EHD3 fragments in the SH-SY5Y cell line. EHD3 435-535 has not shown the ability to aggregate when expressed in SH-SY5Y cells, but full length EHD3 has been shown to aggregate while EHD3 1-434 and EHD3 1-399 have been shown to form aggregate-like clusters. The goal was to investigate if aggregating EHD3 plasmid fragments would induce the non-aggregating EHD3 435-535 to co-aggregate. All proteins were stained with anti-FLAG or anti-GFP primary antibody and GAM 555 secondary antibody. The nuclei were stained blue using DAPI dye. Previous to this experiment, all plasmid fragments were expressed independently to ensure their expression was normal and they served as controls for this co-aggregation experiment (Figure 9, Figure 10). When co-expressed with full length EHD3 fused to the EGFP tag, non-aggregating EHD3 435-535 containing the FLAG tag did not show clear signs of aggregation. The full length EHD3 formed visible aggregates in the cytoplasm of the cell, while EHD3 435-535 showed filamentous expression, the same as it did when expressed individually. EHD3 435-535 did not exhibit any signs of aggregation when co-expressed with EHD3 1-434 or EHD3 1-399 fused with the EGFP tag. Both EHD3 1-434 and EHD3 1-399 formed large clusters in the cytoplasm of the cell while EHD3 435-535 did not form any aggregates but rather maintained its filamentous expression. (Figure 11). In order to ensure the EGFP tag by itself does not affect the expression of EHD3 435-535, the plasmid fragment was also co-expressed with the tag alone (Figure 11).

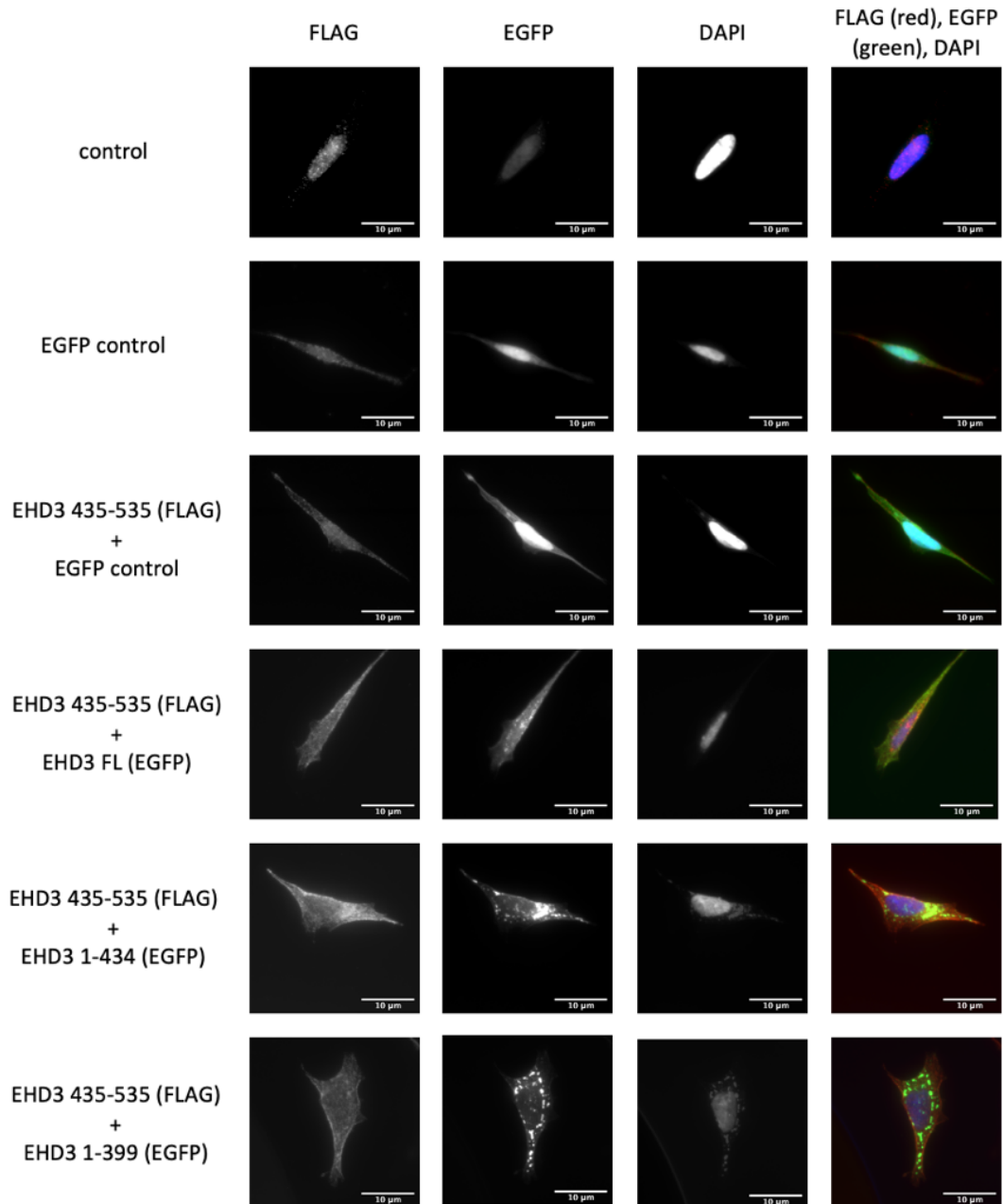

Figure 11. EHD3 FL, EHD3 1-434 and EHD3 1-399 do not induce non-aggregating EHD3 435-535 (FLAG) to aggregation in SH-SY5Y cell line.

Proteins were stained using anti-FLAG (red signal) or anti-GFP (green signal) primary antibody and GAM 555 secondary antibody. Nucleuses were stained blue using DAPI. Images were obtained by 60X magnification using fluorescent microscope and Cell Sens software. The scale bar corresponds to 10 μ m. Control sample represents mock transfected SH-SY5Y cells, while EGFP control represents the expression of EGFP tag in SH-SY5Y cells.

In order to ensure that the results of the co-aggregation experiment were not affected by the presence of the EGFP tag, the same experiment was repeated but with plasmid fragments containing different tags. EHD3 435-535 fused with the EGFP tag was co-expressed with full length EHD3, EHD3 1-434 and EHD3 1-399, all containing the FLAG tag. To confirm that the EGFP tag does not affect their expression, full length EHD3, EHD3 1-434 and EHD3 1-399 were co-expressed with the tag alone.

Full length EHD3 formed aggregates in the cytoplasm of the cell, the same as it does when it is expressed individually. It did not affect the expression of EHD3 435-535 which maintained its filamentous expression. EHD3 1-434 formed clusters resembling aggregates in the cytoplasm of the cell but did not induce the aggregation of non-aggregating EHD3 435-535 as the observed signals of the proteins did not overlap. EHD3 1-399 containing the FLAG tag, which does not aggregate, did not change its expression pattern when co-expressed with EHD3 435-535, nor did it influence the expression of the other plasmid fragment which remained non-aggregating. (Figure 12). All of the proteins exhibited the same expression pattern as they did when expressed individually.

Since both co-aggregation experiments showed the same results, it can be concluded that the EGFP tag does not influence the expression pattern of the proteins and does not affect the results. There were no overlapping signals observed in any of the co-aggregation samples so it can be said that the full length EHD3, EHD3 1-399 and EHD3 1-434 do not induce the aggregation of the non-aggregating EHD3 435-535 plasmid fragment.

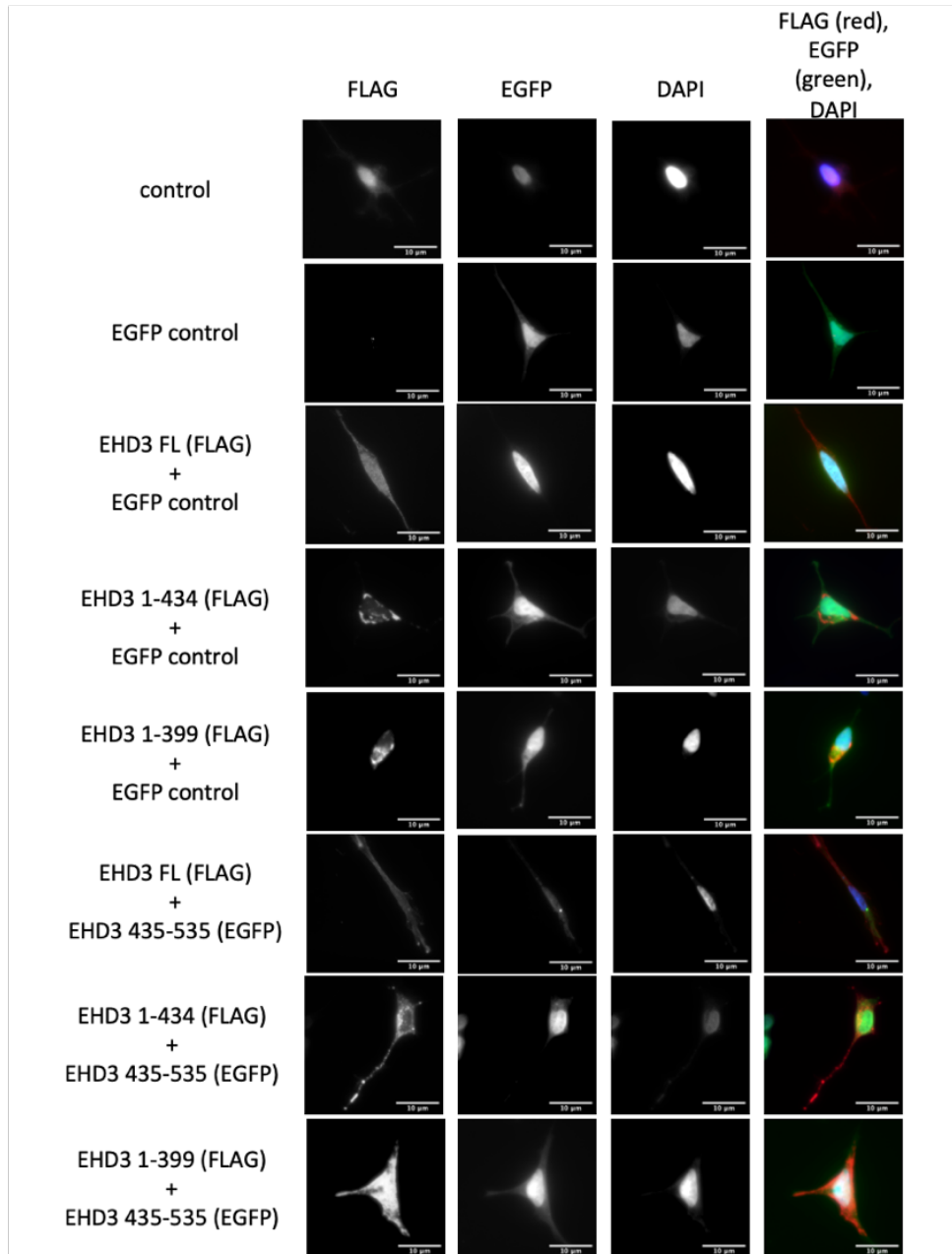

Figure 12. EHD3 FL, EHD3 1-434 and EHD3 1-399 do not induce non-aggregating EHD3 435-535 (EGFP) to aggregation in SH-SY5Y cell line.

Proteins were stained using anti-FLAG (red signal) or anti-GFP (green signal) primary antibody and GAM 555 secondary antibody. Nucleuses were stained blue using DAPI. Images were obtained by 60X magnification using fluorescent microscope and Cell Sens software. The scale bar corresponds to 10 μ m. Control sample represents mock transfected SH-SY5Y cells, while EGFP control represents the expression of EGFP tag in SH-SY5Y cells.

5. Discussion

EHD3, just like the other proteins from the EHD family, has long been considered as a protein involved just in endocytic trafficking and recycling. Recently it has been found in insoluble aggregates formed in brain samples of schizophrenia patients. Aggregation of proteins and its involvement in the development of mental illnesses has been a topic of interest in recent SMI research. Since it has been shown that EHD3 aggregates in schizophrenia brain samples, while in healthy brain samples it does not, EHD3 may also play a role in the development of schizophrenia or other SMIs, in interaction with other risk factors. In order to better understand its role in the occurrence of schizophrenia we need to further our knowledge about the behaviour of EHD3 and the mechanism of its aggregation. Previous results showed that deleting the EH domain abolished EHD3 aggregation, however it is not yet clear if the EH domain alone is sufficient for the protein's aggregation.

5.1. The EH domain does not aggregate independently, the aggregation of EHD3 is most likely influenced by more than one structural region.

The first step in the understanding of the EHD3 aggregation mechanism is determining the region of the protein that is crucial for its aggregation. Identification of this region would allow us to specifically target that region of EHD3 in order to prevent it from aggregating and to generate a form of EHD3 that would be resistant to aggregation. This would then allow for further research on the role of EHD3 in schizophrenia development and how EHD3 aggregation affects cells. By understanding the mechanism of EHD3 aggregation, this knowledge could be implemented in the development of

potential drugs that would specifically target the region crucial for EHD3 aggregation and therefore prevent aggregates from forming. Previous research from our laboratory attempted to identify which region would be the one crucial for the aggregation of EHD3 by expressing plasmid fragments in neuroblastoma cells containing different structural regions of the protein and observing their aggregation patterns by fluorescent microscopy. Firstly, the linker region was proposed as crucial for the protein's aggregation. The EHD3 1-399 protein fragment, missing the linker region, showed no signs of aggregation in neuroblastoma cells, while full length EHD3 aggregated and EHD3 1-434 protein fragment clearly clusters, which resemble aggregates, but were later found not to be aggregates. Based on this, our hypothesis was revised to suggest that the EH domain was responsible for aggregation (31)(32). Further research, which observed more EHD3 fragments, found that EHD3 400-535, which does contain the linker region, does not aggregate but binds to actin in the cell. EHD3 1-404, containing only 4 amino acids from the linker region, does not aggregate but shows filamentous expression similarly to EHD3 1-399 (31). The research so far suggests that the EH domain is crucial for aggregation of EHD3, but not by itself. More than one structural region might be responsible for the aggregation of EHD3 by interacting with the EH domain and other molecules forming aggregates.

Results of fluorescent microscopy obtained in this thesis are consistent with the previous results from our lab. EHD3 1-399 and EHD3 400-535 showed filamentous expression. Full length EHD3 showed clear signs of aggregation and EHD3 1-434 formed aggregate-like clusters in neuroblastoma cells. In order to further investigate which region of the protein might be crucial for EHD3 aggregation, novel EHD3 plasmid fragments were expressed in the SH-SY5Y cell line. EHD3 1-434 containing the EGFP tag was newly expressed

to confirm that the tag would not influence its expression pattern. Its expression remained the same, the protein formed large aggregate-like structures in the cytoplasm of the cells, the same as EHD3 1-434 containing the FLAG tag. EHD3 435-535 was also newly expressed. This plasmid fragment contained just the EH domain of the protein. When expressed in neuroblastoma cells, EHD3 435-535 did not show signs of aggregation, both when fused to the FLAG tag and when fused to the EGFP tag. Taking into consideration previous conflicting results it can be concluded that although the EH domain is required for aggregation, as it is abolished when the domain is deleted, it is not capable of inducing aggregation by itself. Therefore, the EH domain in interaction with another structural part of the EHD3 protein must be responsible for the protein's aggregation.

Table 4. List of plasmid fragments used in this thesis and their aggregation pattern when expressed in SH-SY5Y cell line.

Plasmid fragment	Tag	Does it aggregate in SHS-SY5Y cells
Full length EHD3	FLAG	Yes
Full length EHD3	EGFP	Yes
EHD3 1-399	FLAG	No
EHD3 1-399	EGFP	No
EHD3 1-434	FLAG	No
EHD3 1-434	EGFP	No
EHD3 400-535	FLAG	No
EHD3 435-535	FLAG	No
EHD3 435-535	EGFP	No

5.2. Expression of EHD3 435-535 is not altered in the presence of full length EHD3, EHD3 1-434 or EHD3 1-399.

Another aspect of the EHD3 aggregation mechanism that needs to be researched is how different EHD3 fragments interact in the cell and if they co-aggregate. More precisely, it should be determined if one aggregating EHD3 fragment can act as a recruiter protein and induce the aggregation of another, individually non-aggregating, EHD3 fragment. Investigating this tendency of the protein would allow for a better understanding of the schizophrenia patient's brain structure. Do the aggregates found in brain samples consist of just aggregating protein fragments or does a smaller fraction of aggregating fragments induce non-aggregating ones to co-aggregate? Also, it would allow for further research on how exactly co-aggregation appears and which regions are crucial for the interaction between fragments. The findings about co-aggregation tendencies of EHD3 fragments would be implemented in research on how to prevent co-aggregation which would be useful in drug development. Previous research from our laboratory tested co-aggregation of EHD3 fragments by co-expressing EHD3 1-399 with full length EHD3 and EHD3 1-434 in neuroblastoma cells. EHD3 1-399 is a non-aggregating EHD3 fragment that does not contain the linker region while EHD3 1-434 forms large aggregate-like clusters and does contain the linker region of the protein. Full length EHD3 also forms aggregates in the cell. It was observed that when co-expressed with aggregating proteins, EHD3 1-399 also formed aggregates which were seen as a yellow signal resulting from overlapping aggregates. In the case of EHD3 1-434 it was not confirmed that they co-aggregate but hypothesised that, since EGFP tag influences the expression pattern of EHD3 1-399 and EHD3 1-434 more likely forms clusters than aggregates, they strongly interact with each other but do not co-aggregate (31).

In order to further investigate the co-aggregation tendencies of EHD3 fragments, in this thesis we tested new combinations of aggregating and non-aggregating EHD3 plasmid fragments. A non-aggregating EHD3 fragment, EHD3 435-535, was co-expressed with aggregating EHD3 fragments in the SH-SY5Y cell line. The aggregating fragments included full length EHD3 while EHD3 1-434 only forms aggregate-like clusters. EHD3 435-535 was also co-expressed with EHD3 1-399, which does not clearly aggregate but we wanted to see how the fragments would interact. Based on previous results we expected EHD3 435-535 to aggregate and possibly co-aggregate influenced by the interaction with other fragments. The results of fluorescent microscopy did not show any signs of EHD3 435-535 aggregation when co-expressed with other plasmid fragments, nor did they co-aggregate. Full length EHD3 and EHD3 1-434 formed aggregates or aggregate-like structures as usual but did not impact the aggregation of EHD3 435-535. EHD3 1-399 also retained its usual expression and did not interact with EHD3 435-535. The experiment was also done by switching the tags that the plasmid fragments contain to make sure they do not influence the expression pattern of the plasmids, especially the EGFP tag which has been shown to alter the expression of EHD3 1-399. The observed results did not change after switching the tags of the proteins, meaning they do not influence the interactions of the co-expressed proteins and their expression patterns. These results are conflicting with the ones obtained from previous research which showed altered expression of a different EHD3 fragment (amino acids 1-399) when it was co-expressed with aggregating EHD3 fragments. This may be due to the fact that the non-aggregating plasmid fragment from previous research was only lacking the linker and the EH domain, while the non-aggregating EHD3 fragment used for this thesis contained only the EH domain. Therefore, it can be hypothesised that the EH domain is important for the initialization of the aggregation of EHD3, but it

interacts with other regions in order for the aggregation to happen. It is likely that the helical and/or the G domain then interact to bring more molecules into the aggregate, therefore allowing for aggregates to form. Since the previous research showed that EHD3 1-399, which lacks the linker region, co-aggregates with full length EHD3 the linker region is probably not responsible for the interaction between protein fragments. To further understand if and how one EHD3 fragment might induce the aggregation or co-aggregation of another EHD3 fragment, similar experiments should be made by co-expressing the same aggregating EHD3 fragments (full length EHD3, EHD3 1-434) with structurally different non-aggregating protein fragments, consisting of only the helical regions or the ATP binding domain.

5.3. Future research

The aggregation of EHD3 proved to be a very complex mechanism that has yet to be fully understood. In order to expand our knowledge about this biological process further research is needed. Firstly, the region crucial for the aggregation of the protein remains unknown despite all the research that has already been done. To better identify which region is crucial for EHD3 aggregation alongside the EH domain, new constructs should be made and expressed in neuroblastoma cells. Since the EH domain proved not to aggregate, novel fragments should contain the linker region and either the helical region or the ATP binding domain to determine if those domains interact, causing the protein to aggregate. Furthermore, since it is not clear if EHD3 1-434 actually aggregates, it should be validated using physical and analytical methods. As planned, EHD3 1-411, EHD3 1-420 and EHD3 1-426 should be generated and expressed to investigate the aggregation pattern of EHD3 1-434. These fragments would contain different fragments of the linker region so it would help determine if and how the linker region influences the formation of clusters that resemble aggregates. Although it

has been shown in previous research in our laboratory that EHD3 does not co-aggregate with DISC1, Dysbindin 1A and TRIOBP-1 it should be investigated if it interacts with any other proteins or aggregates by itself. When researching co-aggregation of EHD3 fragments, future experiments should include co-expression of novel constructs with full length EHD3 and EHD3 1-434 to determine which structural region of the protein is crucial for the interaction with other fragments. The constructs would consist of helical domains and the ATP binding region, since the EH domain proved not to be involved in interacting with aggregating fragments. EHD3 1-285, EHD3 286-535 and EHD3 57-285 should firstly be generated and expressed independently to determine if they aggregate or not. If they do not aggregate, as expected, they would be co-expressed with full length EHD3 and EHD3 1-434 to determine if their expression would alter and if the proteins would co-aggregate. This would help determine if helical regions or the ATP binding domain of EHD3 are involved in interactions with aggregating proteins leading to alterations in its expression. The goal is to understand the mechanism of EHD3 aggregation so an aggregation resistant EHD3 could be constructed, and the effects of such a protein could be investigated in mammalian cells and animal models such as *D. melanogaster*. The effects of a non-aggregating EHD3 could be compared to the effects of aggregating EHD3 thus furthering our understanding how the aggregation of EHD3 might affect the pathophysiology of schizophrenia. EHD3 research could overall better our understanding of underlying pathways of schizophrenia and protein aggregation linked to SMI.

6. Conclusion

Protein aggregation is considered a possible biological cause of SMIs, including schizophrenia. It occurs as a result of accumulating misfolded proteins due to the disruption of different cellular mechanisms. EHD3 is a protein from the EHD protein family that is involved in the regulation of endocytic recycling and trafficking as well as the internalization of D1 dopamine receptors. It is also one of the proteins that have been found to aggregate in the brains of schizophrenia patients. Previous research showed the EH domain as crucial for the aggregation of EHD3. In this thesis it has been shown, however, that the EH domain (EHD3 435-535) does not independently aggregate, which implies that, even though it is required for the aggregation of EHD3 it is not enough alone for the aggregation to happen. The aggregation probably occurs through the interaction of the EH domain and another structural region. Although previous research saw changes in aggregation when a non-aggregating EHD3 fragment (amino acids 1-399) was co-expressed with full length EHD3, in this thesis we did not observe the aggregation or co-aggregation of EHD3 435-535 under the influence of other protein fragments, meaning that the EH domain cannot be made to aggregate by the aggregating full length EHD3. It is therefore likely that the EH domain is required and plays an essential role in initiating aggregation, but the growth of the (co)aggregate depends on another part of the EHD3 protein. Further interactions with other molecules that make up the aggregates are likely made through other structural regions such as the helical and/or the G domain. Future research should explore the interaction of the EH domain and other regions as well as regions crucial for protein interactions leading to co-aggregation. Understanding EHD3 aggregation mechanism will lead to a better understanding of underlying biological pathways of schizophrenia.

Financial support

This research was supported by grants from the Croatian Science Foundation (HRZZ: Hrvatska zaklada za znanost): IP-2018-01-9424, "Istraživanje shizofrenije kroz ekspresiju netopivih proteina (ISkrEN)" and the Alexander von Humboldt Foundation: 1142747-HRV-IP, "DISC1: Is Structure, Aggregation and Relationship to Disease (DISCARD).

7. Literature

1. Schizophrenia [Internet]. [cited 2023 Aug 8]. Available from: <https://www.who.int/news-room/fact-sheets/detail/schizophrenia>
2. NIMH » Mental Illness [Internet]. [cited 2023 Aug 8]. Available from: <https://www.nimh.nih.gov/health/statistics/mental-illness>
3. Owen MJ, Sawa A, Mortensen PB. Schizophrenia. *Lancet*. 2016 Jul 2;388(10039):86–97.
4. ICD-11 for Mortality and Morbidity Statistics [Internet]. [cited 2023 Aug 8]. Available from: <https://icd.who.int/browse11/l-m/en#/http%3A%2F%2Fid.who.int%2Ficd%2Fentity%2F1683919430>
5. Gaebel W, Zielasek J. Schizophrenia in 2020: Trends in diagnosis and therapy. *Psychiatry Clin Neurosci*. 2015 Nov 1;69(11):661–73.
6. Gogtay N, Vyas NS, Testa R, Wood SJ, Pantelis C. Age of Onset of Schizophrenia: Perspectives From Structural Neuroimaging Studies.
7. Charlson FJ, Ferrari AJ, Santomauro DF, Diminic S, Stockings E, Scott JG, et al. Global Epidemiology and Burden of Schizophrenia: Findings From the Global Burden of Disease Study 2016. *Schizophr Bull*. 2018;44(6):1195–203.
8. Stępnicki P, Kondej M, Kaczor AA. Current Concepts and Treatments of Schizophrenia. Vol. 23, *Molecules*. 2018.
9. Ľupták M, Michaličková D, Fišar Z, Kitzlerová E, Hroudová J, Professor A. *World Journal of Psychiatry* Novel approaches in schizophrenia-from risk factors and hypotheses to novel drug targets Conflict-of-interest statement: Open-Access. 2021;11(7):277–96.
10. Protein Folding and Processing - The Cell - NCBI Bookshelf [Internet]. [cited 2023 Aug 9]. Available from: <https://www.ncbi.nlm.nih.gov/books/NBK9843/>
11. Ochneva A, Zorkina Y, Abramova O, Pavlova O, Ushakova V, Morozova A, et al. Protein Misfolding and Aggregation in the Brain: Common

- Pathogenetic Pathways in Neurodegenerative and Mental Disorders. *Int J Mol Sci.* 2022 Nov 1;23(22).
12. Wen JH, He XH, Feng Z Sen, Li DY, Tang JX, Liu HF. Cellular Protein Aggregates: Formation, Biological Effects, and Ways of Elimination. *Int J Mol Sci.* 2023 May 1;24(10).
 13. Cukkemane A, Becker N, Zielinski M, Frieg B, Lakomek NA, Heise H, et al. Conformational heterogeneity coupled with β -fibril formation of a scaffold protein involved in chronic mental illnesses. *Transl Psychiatry.* 2021;11(1).
 14. Nucifora LG, Wu YC, Lee BJ, Sha L, Margolis RL, Ross CA, et al. A Mutation in NPAS3 That Segregates with Schizophrenia in a Small Family Leads to Protein Aggregation. *Complex Psychiatry.* 2016;2(3):133–44.
 15. Zaharija B, Odorčić M, Hart A, Samardžija B, Marreiros R, Prikulis I, et al. TRIOBP-1 Protein Aggregation Exists in Both Major Depressive Disorder and Schizophrenia, and Can Occur through Two Distinct Regions of the Protein. *Int J Mol Sci.* 2022;23(19).
 16. Bader V, Tomppo L, Trossbach S V., Bradshaw NJ, Prikulis I, Rutger Leliveld S, et al. Proteomic, genomic and translational approaches identify CRMP1 for a role in schizophrenia and its underlying traits. *Hum Mol Genet.* 2012;21(20):4406–18.
 17. Yang W, Zhu C, Shen Y, Xu Q. The pathogenic mechanism of dysbindin-1B toxic aggregation: BLOC-1 and intercellular vesicle trafficking. *Neuroscience.* 2016 Oct;333:78–91.
 18. Marreiros RMG. Protein homeostasis dysfunction in chronic brain disorders. 2019;(July).
 19. Bahl K, Xie S, Spagnol G, Sorgen P, Naslavsky N, Caplan S. EHD3 Protein Is Required for Tubular Recycling Endosome Stabilization, and an Asparagine-Glutamic Acid Residue Pair within Its Eps15 Homology

- (EH) Domain Dictates Its Selective Binding to NPF Peptides *. 2016;
20. Naslavsky N, Caplan S. EHD proteins: Key conductors of endocytic transport.
 21. Galperin E, Benjamin S, Rapaport DD, Rotem-Yehudar R, Tolchinsky S, Horowitz M. EHD3: A protein that resides in recycling tubular and vesicular membrane structures and interacts with EHD1. *Traffic*. 2002 Aug 1;3(8):575–89.
 22. Spagnol G, Calliste R#, Kieken F, Caplan S, Sorgen PL. Chemical Shift Assignments of the C-terminal Eps15 Homology Domain-3 EH Domain*.
 23. Varadi M, Anyango S, Deshpande M, Nair S, Natassia C, Yordanova G, et al. AlphaFold Protein Structure Database: massively expanding the structural coverage of protein-sequence space with high-accuracy models. *Nucleic Acids Res*. 2022 Jan 7;50(D1):D439–44.
 24. Pettersen EF, Goddard TD, Huang CC, Couch GS, Greenblatt DM, Meng EC, et al. UCSF Chimera--a visualization system for exploratory research and analysis. *J Comput Chem*. 2004 Oct;25(13):1605–12.
 25. Jumper J, Evans R, Pritzel A, Green T, Figurnov M, Ronneberger O, et al. Highly accurate protein structure prediction with AlphaFold. *Nature*. 2021 Aug;596(7873):583–9.
 26. Naslavsky N, McKenzie J, Altan-Bonnet N, Sheff D, Caplan S. EHD3 regulates early-endosome-to-Golgi transport and preserves Golgi morphology. *J Cell Sci*. 2009 Feb 1;122(Pt 3):389–400.
 27. Lu Q, Insinna C, Ott C, Stauffer J, Pintado PA, Rahajeng J, et al. Early steps in primary cilium assembly require EHD1/EHD3-dependent ciliary vesicle formation. *Nat Cell Biol*. 2015 Mar 2;17(3):228–40.
 28. Kotowski SJ, Woodward Hopf F, Seif T, Bonci A, Von Zastrow M. Endocytosis Promotes Rapid Dopaminergic Signaling.
 29. Mamoor S. The Eps15 homology (EH) domain-containing protein 3,

EHD3 is differentially expressed in the brains of patients with schizophrenia.

30. Dashi G. Screening of proteins with the potential to aggregate in mental illness [undergraduate thesis, University of Rijeka]. 2019 Jul 23;
31. Fartek T. EHD3 aggregation depends on more than one critical region [master's thesis, University of Rijeka]. 2022 Sep 19;
32. Ruhije Bertoša S. Determining the regions of protein EHD3 that cause its aggregation in schizophrenia [master's thesis, University of Rijeka]. 2021.

List of tables

Table 1. Fluorescent markers and primary and secondary antibodies used for Western blotting and immunocytochemistry.....	18
Table 2. List of plasmids.....	19
Table 3. Chemicals volumes used for preparation of different concentrations of acrylamide gels and sample sizes they were used for.....	26
Table 4. List of plasmid fragments used in this thesis and their aggregation pattern when expressed in SH-SY5Y cell line.....	45

List of figures

Figure 1. Neurochemical hypotheses of schizophrenia.....	7
Figure 2. Mechanisms of protein misfolding and aggregation.....	9
Figure 3. Mechanisms of eliminating protein aggregates in the cell.....	11
Figure 4. EHD3 protein structure (4A – schematic representation; 4B – 3D structure).....	14
Figure 5. Structures of EHD3 fragments used for this thesis.....	30
Figure 6. Western blots of EHD3 plasmid fragments containing the FLAG Tag.....	31
Figure 7. Western blots of EHD3 plasmid fragments containing the EGFP Tag.....	32
Figure 8. EHD3 FL aggregates, EHD3 1-434 forms aggregate-like clusters, and EHD3 1-399 does not aggregate in HEK293 cell line.....	34
Figure 9. EHD3 FL and EHD3 1-399 aggregate, EHD3 1-434 forms aggregate-like clusters, and EHD3 400-535 does not aggregate in SH-SY5Y cell line.....	36
Figure 10. EHD3 435-535 and EHD3 1-434 do not aggregate, but EHD3 1-	

434 forms aggregate-like clusters in SH-SY5Y cells..... 38

Figure 11. EHD3 FL, EHD3 1-434 and EHD3 1-399 do not induce non-aggregating EHD3 435-535 (FLAG) to aggregation in SH-SY5Y cell line..... 40

Figure 12. EHD3 FL, EHD3 1-434 and EHD3 1-399 do not induce non-aggregating EHD3 435-535 (EGFP) to aggregation in SH-SY5Y cell line..... 42

EMA UKIĆ

 **Home** : Tumpići 16, 51414, Veprinac, Croatia

 **Email**: ema.ukic@gmail.com  **Phone**: (+385) 916302255

Gender: Female **Date of birth**: 10/04/1999 **Nationality**: Croatian

EDUCATION AND TRAINING

[2021 – 2023]

Biotechnology in Medicine, Masters degree

Department of Biotechnology, University of Rijeka

City: Rijeka

Country: Croatia

[2017 – 2021]

Biotechnology and Drug Research, Bachelor degree

Department of Biotechnology, University of Rijeka

City: Rijeka

Country: Croatia

[2013 – 2018]

High school diploma

Gimnazija Andrije Mohorovičića Rijeka

City: Rijeka

Country: Croatia

WORK EXPERIENCE

[05/2021 – 07/2021]

Intern

Liburnijske vode d.o.o.

City: Opatija

Country: Croatia

Interning in a laboratory performing microbiological and analytical testing of drinking and sea water

[08/2020 – 03/2021]

Administrative assistant and English tutor

Euroway Kastav d.o.o

City: Kastav

Country: Croatia

Tutoring English to elementary school children, interacting with clients and maintaining office facilities

[08/2018 – 12/2019]

English tutor

DND Kastav

City: Kastav

Country: Croatia

Tutoring English to elementary school children with socioeconomic disadvantages

[05/2022 – Current]

Food supplement promotion demonstrator

Avemed d.o.o.

City: Rijeka

Country: Croatia

Performed measurements of patients vitamin and mineral levels and provided advice and information about food supplements to help improve their well being whilst promoting Terranova products.

LANGUAGE SKILLS

Mother tongue(s): Croatian

Other language(s):

English

LISTENING C1 READING C1 WRITING C1

SPOKEN PRODUCTION C1 SPOKEN INTERACTION C1

German

LISTENING A1 READING A1 WRITING A1

SPOKEN PRODUCTION A1 SPOKEN INTERACTION A1

Levels: A1 and A2: Basic user; B1 and B2: Independent user; C1 and C2: Proficient user

DIGITAL SKILLS

Microsoft Office

Microsoft Word | Microsoft Excel | Microsoft Powerpoint

Molecular imaging

PyMol | GAMESS - General Atomic and Molecular Electronic Structure System | UCSF Chimera | VMD – Visual Molecular Dynamics | Avogadro

CERTIFICATES

[2014] **Cambridge English Level 2 Certificate in ESOL International**

[2015]

Completed German course at John Milton School of foreign languages, Rijeka

HONOURS AND AWARDS

The City of Opatija Scholarship for Academic Excellence (2015 - present)

[05/2023] **2nd place in the STEM games Science arena**

Competed in solving problems in the field of bioinformatics, biotechnology, biology and bioengineering.

DRIVING LICENCE

Cars: B