

Genetic ablation of ADAR1, ADAR2 and ADAR3 using CRISPR/Cas9 technology

Ivanišević, Vlatka

Master's thesis / Diplomski rad

2023

Degree Grantor / Ustanova koja je dodijelila akademski / stručni stupanj: **University of Rijeka / Sveučilište u Rijeci**

Permanent link / Trajna poveznica: <https://um.nsk.hr/um:nbn:hr:193:824687>

Rights / Prava: [In copyright](#) / [Zaštićeno autorskim pravom.](#)

Download date / Datum preuzimanja: **2024-11-05**

Repository / Repozitorij:



[Repository of the University of Rijeka, Faculty of Biotechnology and Drug Development - BIOTECHRI Repository](#)



UNIVERSITY OF RIJEKA
DEPARTMENT OF BIOTECHNOLOGY
Master by Research
Biotechnology for the Life Sciences

Vlatka Ivanišević

**Genetic ablation of ADAR1, ADAR2 and ADAR3 using CRISPR/Cas9
technology**

Master's thesis

Rijeka, 2023

UNIVERSITY OF RIJEKA
DEPARTMENT OF BIOTECHNOLOGY
Master by Research
Biotechnology for the Life Sciences

Vlatka Ivanišević

**Genetic ablation of ADAR1, ADAR2 and ADAR3 using CRISPR/Cas9
technology**

Master's thesis

Rijeka, 2023
Mentor: Igor Jurak, Ph.D., Assoc. Prof.

SVEUČILIŠTE U RIJECI
ODJEL ZA BIOTEHNOLOGIJU
Diplomski studij
Biotechnology for the Life Sciences

Vlatka Ivanišević
**Genetička ablacija ADAR1, ADAR2 i ADAR3 koristeći CRISPR/Cas9
tehnologiju**
Diplomski rad

Rijeka, 2023
Mentor: izv.prof.dr.sc. Igor Jurak

Acknowledgements

I am immensely grateful to everyone who supported me throughout the journey of completing this thesis. Their guidance, encouragement, and unwavering support played a pivotal role in shaping this work.

I extend my heartfelt gratitude to my mentor, Igor Jurak, whose expertise, patience, and dedication have been a constant source of inspiration.

I'd want to thank my lab mates for their friendship and invaluable assistance and support. You helped me believe in me and made my days in the lab enjoyable and fun.

Finally, I would like to extend my thanks to my family and friends for their encouragement and support throughout my master's degree journey. Your love and faith in me have been a constant source of encouragement to keep going.

Master's thesis was defended on 26th of September 2023 at the Department of Biotechnology, University of Rijeka, in front of committee:

1. Jelena Ban, PhD
2. Katarina Kapuralin, PhD
3. Igor Jurak, PhD (mentor)

Thesis contains 48 pages, 12 figures, 1 supplementary table and 36 references.

ABSTRACT

Posttranscriptional modifications are poorly understood cellular phenomenon. C6 deamination of adenosine to inosine is a common dsRNA modification carried out by ADAR family of enzymes. ADAR1, the chief editor, has two isoforms: interferon inducible p150 and constitutively expressed p110. ADAR2 is the other active cellular editor, while ADAR3 has no notable editing activity. Editing alters RNA structure leading to induction of various changes. Both RNA and DNA molecules are edited by ADAR. While cellular editing by ADARs plays a role in maintaining cellular homeostasis, the phenomenon has also been recorded during viral infection. Although they are well documented editors in infection with dsRNA viruses, role of ADARs during infection with dsDNA viruses remains unclear and seemingly varies. This project aimed to explore the role ADARs play during infection with dsDNA viruses using HSV-1 as a model. CRISPR/Cas9 method was used to try to generate ADAR KO cells lines. While ADAR2 KO failed, ADAR1 KO was partly successful. An improved CRISPR/Cas9 system that uses conditional expression might be used to successfully generate these cell lines. ADAR3 protein levels were undetectable by Western blot, so success of KO remains to be tested. Interferon inducible p150 isoform of ADAR1 was successfully ablated, while its p110 isoform remains functional. Such cell line opens the possibility of further exploring the role of p150 isoform during infection with HSV-1 and other dsDNA viruses.

Key words: ADAR, ADAR1 p150, ADAR2, ADAR3, viral infection, HSV-1, dsDNA, CRISPR/Cas9

SAŽETAK

Posttranskripcijske modifikacije nedovoljno su shvaćeni stanični fenomen. C6 deaminacija adenzina u inozin je česta modifikacija dvolančane RNK koju provodi obitelj enzima ADAR. ADAR1, glavni *editor*, ima dvije izoforme: interferonom inducibilni p150 i konstitutivno eksprimirani p110. ADAR2 je drugi aktivni efektor, dok ADAR3 nema zapaženu aktivnost modificiranja. Modifikacijom se mijenja struktura RNK što dovodi do indukcije raznih promjena. ADAR-i modificiraju i RNK i DNK molekule. Dok stanično modificiranje pomoću ADAR-a igra ulogu u održavanju stanične homeostaze, fenomen je također zabilježen tijekom virusne infekcije. Iako su dobro dokumentirani *editori* u infekciji s dvolančanim RNK virusima, uloga ADAR-a tijekom infekcije s dvolančanim DNK virusima ostaje nejasna i naizgled varira. Ovaj projekt je imao za cilj istražiti ulogu ADAR-a tijekom infekcije dvolančanim DNK virusima koristeći HSV-1 kao model. Metoda CRISPR/Cas9 korištena je za pokušaj stvaranja ADAR KO staničnih linija. Dok ADAR2 KO nije uspio, ADAR1 KO je bio djelomično uspješan. Pobjoljšani CRISPR/Cas9 sustav koji koristi uvjetnu ekspresiju mogao bi se koristiti za uspješno generiranje ovih staničnih linija. Razine ADAR3 proteina nisu bile detektirane Western blotom, tako da uspješnost KO ostaje neodređena i treba se ispitati. Interferonom inducibilna izoforma ADAR1 p150 uspješno je abilirana, dok je njegova izoforma p110 ostala funkcionalna. Takva stanična linija otvara mogućnost daljnjeg istraživanja uloge izoforme p150 tijekom infekcije HSV-1 i drugim dvolančanim DNK virusima.

Ključne riječi: ADAR, ADAR1 p150, ADAR2, ADAR3, virusna infekcija, HSV-1, dsDNA, CRISPR/Cas9

Table of Contents

| | |
|--|----|
| 1. INTRODUCTION | 1 |
| 1.1 Cellular editing phenomena | 1 |
| 1.2 ADAR protein family | 1 |
| 1.3 ADAR role in cellular homeostasis | 3 |
| 1.4 ADAR proteins and viral infection | 6 |
| 1.5 Herpes simplex virus 1 (HSV-1) | 8 |
| 1.6 CRISPR/Cas9 technology | 9 |
| 2. PROJECT AIMS | 13 |
| 3. MATERIALS AND METHODS | 14 |
| 3.1 CRISPR/Cas9 guide RNA design | 14 |
| 3.2 CRISPR/Cas9 guide cloning | 15 |
| 3.2.1 Restriction digestion of backbone and gel purification | 15 |
| 3.2.2 Guide RNA primer dilution and annealing | 16 |
| 3.2.3 Ligation with backbone and bacterial transformation | 17 |
| 3.2.4 Plasmid Midi prep | 18 |
| 3.2.5 Check restriction digestion and sequencing analysis | 19 |
| 3.3 Creation of KO cell lines | 19 |
| 3.3.1 Lentiviral production | 19 |
| 3.3.2 Transduction into target cells | 21 |
| 3.3.3 Antibiotic selection | 21 |
| 3.4 Analysis of KO success | 21 |
| 3.4.1 Western blot | 21 |
| 3.4.2 Immunofluorescence | 23 |
| 4. RESULTS | 25 |
| 4.1 Restriction digestion of backbone | 25 |
| 4.2 Check restriction digestion of annealed guides shows potential successful insertions | 27 |
| 4.3 Sequencing results confirm successful cloning | 30 |
| 4.4 CRISPR/Cas9 successfully knocks out p150 isoform in HEK293A cells | 32 |
| 4.5 Unsuccessful KO of ADAR1 in HEK293T cells | 33 |
| 4.6 Immunofluorescence does not show clear difference | 35 |
| 4.7 ADAR2 KO was not successful | 36 |
| 4.8 ADAR3 was not detected | 37 |
| 5. DISCUSSION | 39 |

| | | |
|-----------|-------------------------------|-----------|
| 6. | CONCLUSION..... | 43 |
| 7. | REFERENCES..... | 44 |
| 8. | SUPPLEMENTAL DATA..... | 49 |

1. INTRODUCTION

1.1 Cellular editing phenomena

RNA-editing is described as change of an RNA sequence induced by nucleotide introduction or removal from the sequence, or nucleobase change as a result of deamination (1). Two main types of editing are substitution editing and insertion/deletion, with substitution being the more common one. There are two prominent families of editing enzymes: APOBEC and ADAR.

APOBEC (Apolipoprotein B mRNA Editing Catalytic Polypeptide-like) family is responsible for deaminating cytosine to uracil residues (C-to-U editing) (2). APOBEC enzyme family edits both RNA and DNA, and can recognise self-nucleic acids, while some enzyme forms have been found to inhibit viral infection via editing (3). Certain members of APOBEC family also exhibit a weak A-to-I editing ability (4).

1.2 ADAR protein family

C6 deamination of adenosine (A) to inosine (I) is a common posttranscriptional modification found in double-stranded RNA (dsRNA). The modification is carried out by a family of enzymes known as ADARs, or adenosine deaminases acting on RNA. As inosine base pairs with cytosine (C) instead of uracil (U) creating less stable mismatch pair, alterations to RNA sequence and structure can happen. These alterations may affect precursor mRNA splicing, messenger RNA (mRNA) decoding, microRNA silencing and, during viral infection, RNA dependent replication by viral polymerases (5).

In mammals, three ADAR genes (ADAR1, ADAR2 and ADAR3) encode four enzymatically active ADAR proteins. ADAR1 (also known as ADAR) is essential for the majority of A-to-I editing processes, including the hyper-editing of cellular and viral RNAs. It is present in two isoforms: interferon inducible

ADAR1 p150 and constitutively expressed ADAR1 p110. They both contain a catalytic deaminase domain in their C-terminal sections as well as three copies of the dsRNA binding domains (RI, RII, and RIII). The main structural difference between the two isoforms is within Z-DNA binding domains; as ADAR1-p150 has two repeated copies, Z α and Z β , in the N-terminal region whereas ADAR1-p110 only has Z β . While p150 can be found both in the nucleus and cytoplasm, p110 is nuclear (6). ADAR1 transcripts undergo alternative splicing, which involves exons 1 and 7. This process results in the generation of two ADAR1 isoforms (7).

ADAR2 (or ADARB1) is primarily responsible for highly site-selective A-to-I editing. Its expression is driven by various constitutive promoters and involves alternative splicing of transcripts. It has two copies of RNA-binding domains in the N-terminal region and a catalytic deaminase domain in the C-terminal region but lacks a Z-DNA binding domain (5).

Unlike ADAR1 and ADAR2, expression of ADAR3 (ADARB2) is mostly restricted to the nervous system, primarily to hippocampus and amygdala. Wild-type (WT) ADAR3 has two copies of dsRNA-binding domains in N-terminal region but exhibits no deaminase catalytic activity (5). ADAR3 shares half of its amino-acid sequence with ADAR2. It possesses an arginine rich motif (called R-domain), which enables single stranded RNA (ssRNA) binding. Another possible function of R-domain is as a nuclear localization signal (NLS) where it is believed editing occurs. ADAR3's novelty means its function remains poorly understood (8). However, specific mutations in the human protein result in the presence of five enzymatic activation sites (9).

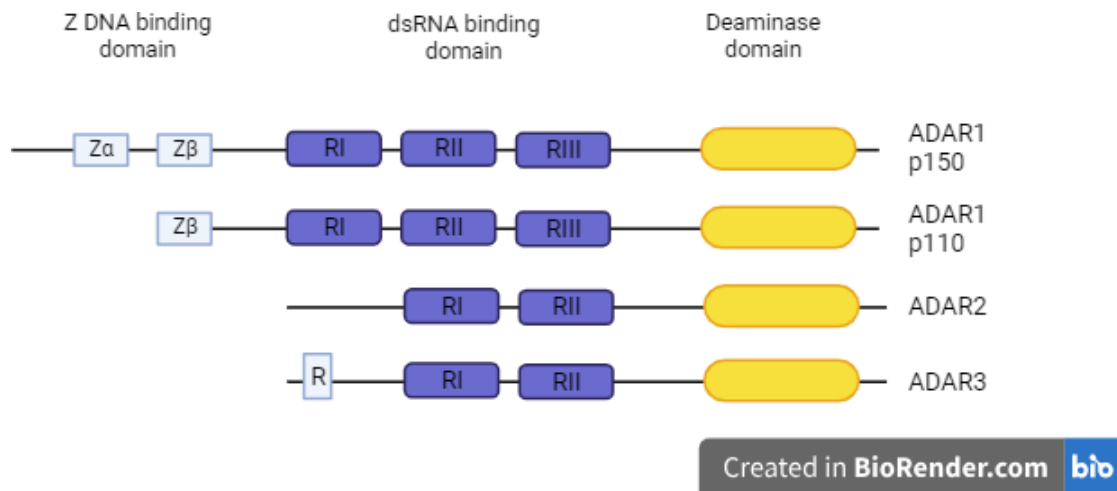

Figure 1: ADAR protein family. Three genes encode four ADAR proteins: two isoforms of ADAR1 (p150 and p110), ADAR2 and ADAR3. P150 isoform of ADAR1 is interferon inducible and has two Z-DNA binding domains, whereas p110 isoform has one. Both isoforms have three copies of the dsRNA binding domains. ADAR2 and ADAR3 proteins have two copies of dsRNA binding domain. ADAR3 has an R-domain on its N-terminal region.

1.3 ADAR role in cellular homeostasis

A-to-I editing by ADARs has a crucial role in regulation of host immune responses. The host immune system can detect pathogenic RNAs via cytosolic RNA sensors in response to exogenous RNAs. To prevent activation of immune response against endogenous RNA, cytosolic sensors should not be activated. ADAR1 mediates A-to-I editing of self dsRNA, preventing endogenous dsRNA recognition. Vast majority of editing happens in repetitive noncoding sequences such as Alu elements. ADAR1 has been identified to be the primary editing deaminase and is the primary cause of hyper-editing. In addition to editing of cellular dsRNA, it is also responsible for hyper-editing of viral dsRNAs (10). The RNA targets that either ADAR1 isoform selectively edits may be

influenced by the difference in the localization of p150 and p110. A consensus interferon-stimulated response element (ISRE) is present in the promoter responsible for p150 expression (11). Studies indicate that ADAR1 mitigates the negative effects of a strong IFN response as extensive editing averts shut down of translation and cellular death (7,12). Additionally, ADAR has functions aside from editing, such as protection of RNA transcripts against degradation (12).

While having a significant effect on preserving cellular homeostasis, abnormalities in editing have been linked to the development of numerous illnesses, including cancer and autoimmune disorders. Studies have shown that hypo-editing in Alu repeats is associated with several tumour types. In human gliomas, lowered editing GRIA2 was detected. Patients with glioblastoma have been classified based on overall editing levels. Additionally, it is assumed ADARs may have a role in autoimmune diseases such as lupus erythematosus due to their engagement in the interferon response pathway (12).

Missense mutations in the human ADAR1 gene lead to development of Aicardi-Goutieres syndrome (AGS), an autoimmune inherited disease associated with spontaneous type I interferon production. It affects brain and skin. Most children affected develop mild to severe physical or intellectual impairments. There is no known cure (5,13). Additionally, ADAR1 gene is mutated in people with dyschromatosis symmetrica hereditaria (DSH), an autosomal genetic condition that affecting skin, however underlying mechanisms are still unknown. Increased levels of ADAR1 have been seen in esophageal, lung and hepatocellular carcinomas as well as lymphoproliferative diseases, and have been linked to a bad prognosis in some cases. ADAR1-mediated editing of AZIN1 is associated with hepatocellular carcinoma, influencing cell proliferation and invasion by regulating polyamine homeostasis. Additionally,

high levels of A-to-I editing of the Ras homolog family member Q have been linked to increased tumour invasion in colorectal cancer (12). In mouse models, expression disruption of both ADAR1 isoforms as well as disruption of only p150 leads to embryonic lethality. Genetic knock-in of a catalytically dead ADAR1 mutant lead to the same fate (5).

While both ADAR1 and ADAR2 proteins have distinct substrate selectivity, there are overlapping preferences with certain substrates. Both the RNA binding domains and the deaminase domain determine substrate selectivity. Unlike ADAR1, expression and activity of ADAR2 are not influenced by interferon. ADAR2 modulates its own gene expression by influencing the splicing process of its precursor RNA molecules. It is primarily accountable for the precise and specific A-to-I editing in mammalian cells (5,14). Aberrant editing mediated by ADAR2 has been linked with central nervous system disorders (12). ADAR2 deficiency has been linked to Amyotrophic lateral sclerosis (ALS) and astrocytoma (a most common type of brain tumour) (13). In patients affected by epilepsy increased editing of GRIA2 has been identified (15). Additionally, changes in editing levels of GRIA2 and other transcripts may add to ALS. Likewise, lowered editing levels of the serotonin receptor 5-HT_{2C} influence production of serotonin and contribute to various psychiatric disorders. Furthermore, same changes in editing have been observed in Alzheimer's patients and prefrontal cortex of suicide victims. Hepatocellular carcinoma has been associated with composite effects, where the upregulation of ADAR1 and down-regulation of ADAR2 work together to promote the development of the disease (12). Genetic ablation of ADAR2 in mouse models does not cause embryonic lethality, however mice lacking ADAR2 show diminished survival rates. ADAR2 is essential for maintaining normal physiology in mice (5).

Although ADAR3 itself does not have known deaminase activity, binding to dsRNA structures has been shown to affect efficiency of editing by ADAR2 (5). In mouse models, the genetic removal of *Adar3* does not lead to embryonic lethality. However, mice lacking exon 3 of the *Adar3* gene (which encodes two dsRNA binding domains) show increased levels of anxiety as well as impairments in the formation of short and long-term memory dependent on the hippocampus. Overall, ADAR3 seems to have a role in cognitive processes of mammals (8).

1.4 ADAR proteins and viral infection

Recently ADARs have emerged as important effectors in viral infection. As intracellular parasites, viruses have evolved strategies to exploit numerous, and in some instances, all host gene expression mechanisms as part of their integration into the host's cellular processes. Organisms, along with their pathogens, employ RNA modification as an established mechanism to optimize RNA structure and function, thereby regulating gene expression. ADARs and A-to-I editing play a crucial role in modulating host immune responses as well as viral replication. The effects of A-to-I substitutions can vary from antiviral to proviral or even negligible, contingent upon the specific virus, the particular ADAR deaminase involved, and the prevailing physiological conditions (5).

During viral infection with positive-stranded RNA viruses dsRNA is formed, presenting possible editing target for ADAR enzymes. By destabilising RNA, ADARs play a role in primary defence against RNA viruses. While ADAR1 is involved in regulation of replication in a number of RNA viruses, ADAR2 has so far only been found to influence infection with Borna disease in oligodendroglial cells. Experimental evidence suggests that ADAR1 can potentially restrict the replication of viral RNA, as observed in human liver cells when ADAR1 is genetically knocked down, resulting in a significant increase in hepatitis C virus

replication. On the other hand, ADAR1 activity may have the opposite effect by promoting the replication of measles virus and influenza virus (16). Currently it is believed that ADARs can exert their influence through various mechanisms during viral infections such as directly impact viral RNA through editing, leading to altered viral infection outcomes, or indirectly affect viral interactions with the host by editing cellular RNAs, which then influence cellular products involved in viral interactions. Furthermore, ADARs might function in an editing-independent manner by modifying protein or nucleic acid binding interactions. In cases where ADARs acts directly onto viral nucleic acids two different ADAR1 isoforms may have a key role. In viruses that solely replicate within the cytoplasm, it is presumed that the p150 isoform of ADAR1 would be the primary effector. On the other hand, viruses that involve a nuclear component in their replication process, dsDNA viruses and orthomyxoviruses can theoretically be edited by both ADAR1 and ADAR2. The diverse effects of ADARs, whether favouring or countering viral activity, are likely rooted in significant functional distinctions among various viral replication strategies. Comprehensive genomic analyses have unveiled the utilisation of numerous host cell mechanisms by viruses throughout their replication cycles. Variations in the timing and spatial dynamics of viral interactions with their hosts during replication, even among two viruses capable of multiplying within similar host cell types, can contribute to distinct functional outcomes linked to the actions of ADARs. Furthermore, it is increasingly evident that ADARs can exert indirect effects on the infectious process. For instance, in cases where viral infection leads to the upregulation of ADAR1, the induced ADAR p150 protein might modulate innate immune signalling reactions. This includes the activation of interferon responses and cellular reactions triggered by double-stranded RNA (dsRNA), such as PKR and IRF3 pathways. These activations of PKR and IRF3 are then anticipated to elicit widespread impacts on the host's collection of transcripts and proteins. Computational approaches and following biochemical

analyses have further showed that several non-coding RNAs are subject to ADAR-mediated editing. This includes microRNAs, impacting their expression and roles (13).

As ADARs have first been identified as RNA editors, their role in RNA virus infection is well explored. The ADAR1-p150 isoform has been identified as an important part of host immune response during infection with different RNA viruses (7). Although they are primarily editors of dsRNA, ADARs can also edit dsDNA. It has been found that ADARs also edit dsDNA viruses during infection of the host (11). However, lesser is known about their mechanisms and effect in infection with DNA viruses.

1.5 Herpes simplex virus 1 (HSV-1)

Herpes simplex virus 1 (HSV-1) is a frequent human pathogen mostly known for causing cold sores (17). Although mostly known for causing minor infections, in immunocompromised patients it can cause severe or life-threatening illnesses such as encephalitis and keratoconjunctivitis (18). Among the extensively examined viruses, HSV-1 stands out as a prominent subject of research serving as a versatile model for investigating various cellular mechanisms such as antiviral responses. Furthermore, it is employed as a vector in cancer therapy strategies. Similar to all other members within the herpesvirus lineage, the replication process of HSV-1 can be separated into two discernible stages of infection: the productive phase and the latent phase. After infecting the epithelial cells in the oropharyngeal region, the virus commences the productive (lytic) phase of infection. This stage is marked by a well-regulated and abundant sequence of gene expression events. The initial expression phase is dominated by immediate early proteins (IE), primarily composed of transcription factors and inhibitors of innate immunity followed by expression of proteins essential for viral DNA replication lacking a structural

role, referred to as early (E) proteins (such as UL30, thymidine kinase, DNA polymerase etc.). Once DNA replication begins, expression of late (L) genes encoding mainly structural proteins commences. Formed nucleocapsids undergo intricate maturation and envelopment processes prior to exiting the cell and spreading. After a productive infection, the virus proceeds to enter sensory neurons that reach the primary infection site, where it establishes a lifelong latent infection, also called latency (17). Trigeminal ganglia (TG) serve as the primary repository for latent HSV-1 genomes, a role they often share with varicella zoster virus (VZV), another neurotropic alphaherpesvirus (18). Unlike the swift and extensive gene expression and viral propagation observed during productive infection, latency entails significant suppression of viral genes, accompanied by the absence of viral progeny formation. Throughout the latent infection phase, a notable abundance of expression is limited to latency-associated transcripts (LATs). These LATs give rise to multiple microRNAs (miRNAs) as well as a remarkably stable long non-coding RNA (lncRNA) in the configuration of a LAT intron (17). Although the precise functions of LATs remain to be fully elucidated, they have been attributed various biological roles, encompassing the suppression of productive gene expression, modulation of heterochromatin, and prevention of cell death (18). In response to diverse triggers like stress, elevated body temperature, or various environmental influences, the dormant virus can undergo reactivation and migrate along axons. This journey typically leads it back to the locations of the initial infection, instigating recurrent disease (17).

1.6 CRISPR/Cas9 technology

Clustered Regularly Interspaced Short Palindromic Repeat (CRISPR) is a gene editing tool modified from bacterial adaptive immunity. Prokaryotes use CRISPR as a method of protection against mobile genetic elements, where

specialised CRISPR associated endonucleases (Cas) cut the invaders genome into fragments, or protospacers, of around 20 nucleotides in length. Protospacers are integrated into their genome between regularly spaced palindromic repeats, creating sequences that are referred to as CRISPR arrays. In some CRISPR systems, the target sequence is only recognised if the CRISPR complex contains protospacer adjacent motif (PAM), a sequence that is species specific therefore enabling precise recognition. Cas nuclease scans foreign genetic element for PAM sequence. Once it is recognised, Cas protein binds and unwinds DNA and creates a cleavage upstream (19). This mechanism provides prokaryotes with resistance to re-invading pathogens (20). However, anti-CRISPR mechanisms have evolved to combat this form of adaptive immunity (21).

CRISPR, and more recently anti-CRISPR have become the favoured method of genome engineering, surpassing its predecessors such as zinc finger nucleases and TALENS (22). In modified CRISPR systems Cas9 is the most commonly used endonuclease. A guide RNA (gRNA) is synthetically created, around 20 nucleotides in length and contains both scaffold sequence necessary for Cas9 binding and a spacer (with PAM sequence) defining the genomic target. Once the genomic target is located, seed sequence on the 3' end will anneal first followed by the rest of the gRNA in 3' to 5' direction and finishing with a PAM sequence. Cas9 creates double stranded breaks which are repaired using non-homologous end joining (NHEJ) pathway. As NHEJ pathway is error prone, resulting indels can create various mutations in cell population. Most commonly, indels cause amino acid deletions, insertions or frameshift mutations. Ideally indels will lead to loss-of-function mutation within the gene, therefore creating what is referred to as a gene knockout (19).

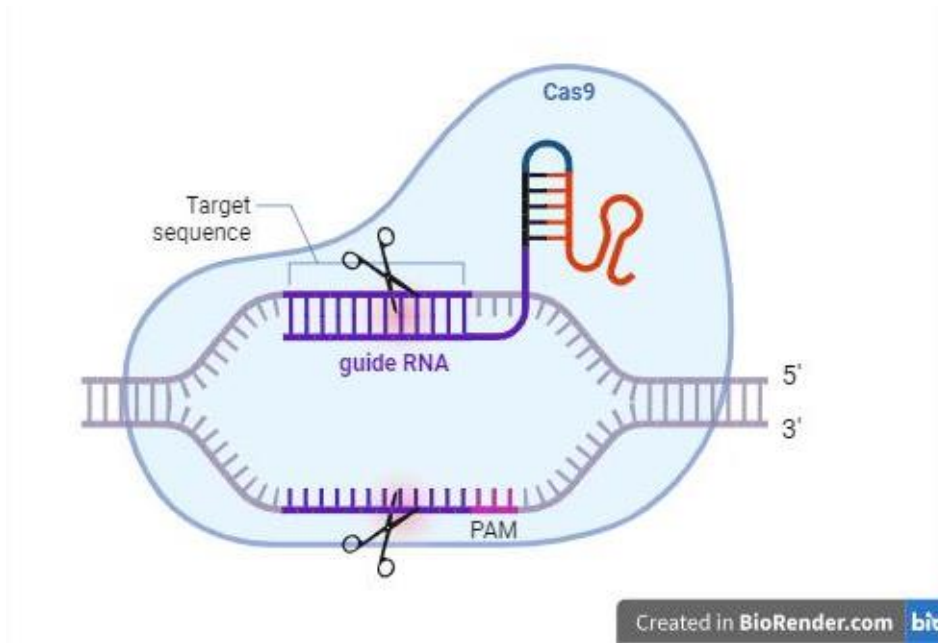

Figure 2: CRISPR/Cas9 genetic scissors. Engineered CRISPR systems comprise of two components: a gRNA and a CRISPR-associated endonuclease (Cas protein). gRNA guides Cas9 protein to the target sequence. Once the PAM sequence is recognised, Cas9 binds to the DNA and creates a double cut which is repaired using cellular NHEJ pathway.

Various new improvements were made to the traditional CRISPR/Cas method since its use was originally reported. Specificity of CRISPR can be enhanced through use of nickases (23) and high-fidelity enzymes to minimise off-target cutting (24). Furthermore, CRISPR can be used to insert a desired sequence instead of simply creating a knockout in order to generate genomic changes in a range from a single nucleotide to large insertions. To achieve this, homology directed repair (HDR) pathway is exploited. DNA double stranded breaks are repaired by two major cellular pathways: the aforementioned NHEJ and HDR. Homology directed repair is much less error prone as it uses a template

sequence. Template is delivered to target cells together with gRNA and Cas and must contain desired changes (23). Other CRISPR variations and improvements include the use of various other Cas proteins and nickases, adapted anti-CRISPR proteins for precise timing of gene editing, gene activation/repression via CRISPR systems, RNA targeting. Its adaptability, relative simplicity and cost-effectiveness make it the most popular genome editing tool in use. This technology holds significant promise as a therapeutic tool, particularly within gene therapy as it enables the precise genetic editing of patient-specific mutations. It also offers potential in addressing human conditions that remain refractory to conventional treatments (25).

2. PROJECT AIMS

A-to-I editing still presents a relatively novel and poorly understood phenomenon. The significance of editing and ADAR proteins in the context of dsDNA infection remains poorly understood and seems to vary. The main aim of this project is to explore the role of ADAR proteins in infection with a common dsDNA virus HSV-1, utilizing it as a model to understand ADAR mechanisms in this type of viral infection.

The approach will involve generating cell lines devoid of ADAR proteins through CRISPR/Cas9 technology. Following successful knock-out of those proteins, viral replication of HSV-1 within these modified cell lines will be examined and compared to wild type (WT) cells. Should the difference in viral growth curve suggest a pro-viral role of ADARs, they could emerge as potential candidates for future antiviral therapeutic strategies. However, a number of groups have shown that depletion of ADAR proteins can be very challenging. We opted to use HEK293 system, which was previously successfully used to generate ADAR1 KO cell line, to establish vectors for depletion of ADARs in different target cells, including neurons.

Specific aims of this project were:

- I. Generate lentiviral vectors for ablation of ADAR1, ADAR2 and ADAR3 protein expression
- II. Transduce HEK293A and HEK293T cells with lentiviral vectors
- III. Select and isolate individual antibiotic resistant clones of transduced cells
- IV. Generate cell lines deficient for expression of ADAR1, ADAR2 or ADAR3
- V. Confirm efficiency of ADAR protein ablation using Western blot and immunofluorescence techniques

3. MATERIALS AND METHODS

3.1 *CRISPR/Cas9 guide RNA design*

Two RNA guides were generated for each ADAR gene to increase effectiveness and possibility of generating a knock-out. The guides for ADAR1 and ADAR2 were obtained from Chung et al 2018 (26). RNA guides for ADAR3 were generated using CRISPick

(<https://portals.broadinstitute.org/gppx/crispick/public>; Broad Institute).

In addition to guides targeting ADAR genes, a guide containing nonsense scramble sequence was created using Sequence Scramble

(<https://www.genscript.com/tools/create-scrambled-sequence>; GenScript)

for 'negative control' (NC) of CRISPR.

Commercial lentiCRISPR v2 plasmid vector (*Addgene*) was used as a cloning vector. Visual representation of BsmBI digested lentiCRISPR v2 with guide RNA inserts was made using SnapGene software.

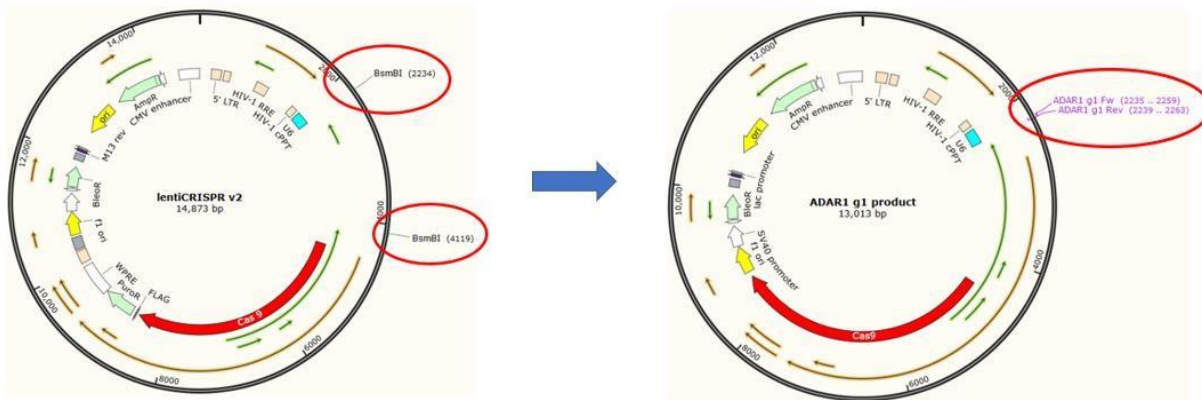

Figure 3: Restriction digestion of vector with BsmBI and gRNA insertion. Schematic view of restriction digestion reaction of lentiCRISPR v2 with BsmBI and following gRNA insertion, shown through example of ADAR1 guide 1 insertion. Commercial vector lentiCRISPR v2 has two designated cut sites for BsmBI vector. Once the cut is made the fragment is discarded and

gRNA is inserted in its place. Once the insertion is complete, vector is ready for cloning. Scheme was created using SnapGene.

3.2 CRISPR/Cas9 guide cloning

3.2.1 Restriction digestion of backbone and gel purification

Cloning of CRISPR guides into lentiCRISPR v2 backbone was performed as per lab protocol. Purified lentiCRIPR v2 plasmid was kindly provided by fellow lab member dr. Mia Cesarec, PhD. Firstly, restriction digestion of backbone was performed. 37,31 ng/ μ l of lentiCRISPR v2 was digested using 50U (units) of BsmBI in 1x 3.1 buffer (*NEB*) and appropriate amount of water. The reaction was left at 55°C for 1 hour. Following backbone digestion, the reaction was loaded on 0,8% agarose gel (*Roth*). Briefly, 0,48g of agarose was added to 60ml of 1x TAE buffer (40 mM Tris, 20 mM acetic acid, 1 mM EDTA, (pH=8,2)) and melted in the microwave oven. Once the resulting gel has cooled down to approximately 50°C, 6 μ l of *GelStar Nucleic Acid Gel Stain 10 000x (Lonza)* fluorescent stain was added and the gel was poured into gel forming tank. A plastic comb was inserted in order for the wells to form in the gel. Once the gel has solidified, it was transferred into electrophoresis tank filled with 1x TAE buffer and the comb was taken out. The sample as well as an undigested vector as a control was mixed with 1 μ l of *DNA Gel Loading Dye, Purple (6x), no SDS (NEB)* and loaded in formed well, and 1 μ l of *QuickLoad 1 kb DNA Ladder (NEB)* was used as a DNA marker. Fragment separation was carried out at 80 V using *Bio-Rad* horizontal electrophoresis system. DNA fragments were visualised and documented using *ChemiDoc MP* imaging system (*Bio-Rad*).

The digested empty backbone was eluted from the gel and purified so that the guide RNAs can be cloned into it. Briefly, position of fragments in gel was

visualised using *Clear View Transilluminator (Clever Scientific Ltd)* and empty backbone was cut out of the gel using a scalpel and transferred into 1,5 ml Eppendorf tubes. DNA was eluted using *Nucleospin Gel and PCR Clean-Up kit (Macherey-Nagel)* according to manufacturer instructions. In short, 500 μ l of NTI binding buffer was added to the Eppendorf tube containing gel cut out. The tube was heated at 50°C for 5-10 minutes, until the gel has completely dissolved. The mixture was then transferred onto the binding column and spun at 11 000 x g for 30 seconds so that DNA binds to silica membrane inside the column. Liquid at the bottom collection tube was discarded and the membrane was washed using 700 μ l NT3 wash buffer and again spun at 11 000 x g for 30 seconds. The liquid at the bottom collection tube was discarded. The column was spun at the same speed for 1 minute to dry the silica membrane. The whole bottom collection tube was discarded and the column was transferred into fresh Eppendorf tube. 30 μ l of NE elution buffer was added on top of the silica membrane and left at room temperature for 1 minute. Then, the tube was spun at 11 000 x g for 1 minute to elute the purified DNA.

3.2.2 Guide RNA primer dilution and annealing

RNA guides are made up of forward and reverse primers that are annealed in PCR machine. The complete set of gRNA sequences can be found within Table S1. 10 μ M of each primer (forward and reverse) for each gRNA was mixed with appropriate amount of water and the mix was incubated at 95°C for 5 minutes, then left to anneal at room temperature for 10 minutes. Then, primer mix was diluted to 0,5 μ M using water and vortexed.

3.2.3 Ligation with backbone and bacterial transformation

Guide RNA s were ligated into lentiCRISPR v2 backbone vector using T4 DNA ligase (*NEB*). Ligation mix was prepared out of 10 μ M of diluted primer mix, digested backbone (100ng per reaction), ligase buffer (*NEB*), 5U of T4 ligase and appropriate amount of water. The mix was incubated at room temperature for 40 minutes.

Bacterial transformation with ligation mix was performed using *NEB 5-alpha Competent E. coli (High Efficiency)* (*NEB*) following manufacturer's protocol. Appropriate number of tubes containing competent bacteria were thawed on ice for 10 minutes. 5 μ l of ligation mix was added to the corresponding tube and flicked to mix. The mixture was left to sit on ice for 30 minutes, then heat shocked at 42°C for 30 seconds. Following heat shock, the bacteria were placed on ice for 5 minutes. 700 μ l of room temperature *SOC Outgrowth Medium* (*NEB*) was pipetted into cell culture tubes and cooled mix was added. Cell culture tubes were placed in the shaker at 37°C for 1 hour and shaken at 250 rpm. Meanwhile, preprepared selection plates were warmed at 37°C.

Briefly, agar plates with ampicillin were prepared by melting agar in the microwave oven. The melted agar was cooled under water to around 50°C. Antibiotic ampicillin was added in ratio 1:1000 to the bottle containing agar. The bottle was mixed and the agar was poured in plates and left to cool. Once cooled, agar plates were stored at 4°C.

Once 1 hour has passed and selection plates were warmed, 500 μ l of bacteria was spread on plates. The plates were incubated overnight at 37°C. Following overnight incubation, selection plates produced colonies of bacteria resistant to ampicillin.

3.2.4 Plasmid Midi prep

Select number of colonies was picked for growth off each plate containing different guides. Colonies were picked using pipette tip and inoculated in 2ml of LB medium with added ampicillin (1:1000) in cell culture tubes. Inoculated colonies were left on shaker overnight at 37°C, 225 rpm. Following day starter culture was transferred into 200ml of LB medium with AMP (1:1000) and left to grow overnight in beforementioned conditions.

Once grown, plasmid midi prep was performed using *NucleoBond Xtra Midi kit for transfection-grade plasmid DNA (Macherey-Nagel)* to extract DNA from colonies. Bacteria were transferred into 50ml Falcon tubes and spun at 4 500 x g, 4°C for 20 minutes. Supernatant was discarded and pellet was resuspended in 8ml of RES resuspension buffer. Following resuspension, 8ml of LYS lysis buffer was added. Falcon tubes were mixed by inverting and left on room temperature for 5 minutes. Meanwhile, extraction column and filter within were equilibrated by wetting them with 12ml of EQU equilibration buffer and left to empty with gravity flow. Following cell lysis, 8ml of NEU neutralisation buffer was added and the tubes were mixed by inverting until the previously blue mixture turned colourless. The lysates were then loaded onto columns and thus filtered. Once the column was cleared by gravity flow, filter was washed with 5 ml of EQU buffer. Following this step, the filter within columns were removed, and second wash was performed using 8 ml of WASH buffer. The WASH buffer has emptied, plasmids was eluted into 15 ml Falcon tubes by adding 5 ml ELU elution buffer to the columns. Eluted plasmids were precipitated by adding 3,5ml of room temperature isopropanol and vortexed thoroughly. Tubes were centrifuged at 4 500 x g at 4°C for 45 minutes and resulting supernatants were carefully discarded. Pellet was washed with 2ml room temperature 70% ethanol, centrifuged at 4 500 x g for 5 minutes at room temperature. Following centrifugation ethanol was carefully removed and

pellet was left to dry at room temperature overnight. Once pellet was dry, it was dissolved in sterile water.

Concentration of plasmids was measured using *BioDrop μ Lite+* (*Biochrom*) spectrophotometer. Briefly, spectrophotometer was calibrated by putting 1 μ l of sterile water in the space between sensors. Once calibrated, the sensors were cleaned and concentration of each sample was measured in the same fashion.

3.2.5 Check restriction digestion and sequencing analysis

Check restriction digestion was carried out to confirm successful insertion of gRNA. Plasmids were redigested with BamHI, PmeI and EcoRI enzymes in appropriate restriction buffer (*NEB*) and water as per manufacturer's instructions and visualised using agarose gel electrophoresis. Restriction digestion and agarose gel electrophoresis were performed as described before.

Plasmid clones that showed expected band sizes were sent for Sanger sequencing, performed by *Macrogen Europe*. Sequencing primer was supplied; sequence ATCATATGCTTACCGTAACT. Analysis of sequencing results was done using *Clone Manager* software. Sequences of lentiCRISPR v2 with gRNA inserts created in *SnapGene* were imported into *Clone Manager*. Expected sequence was then compared to sequenced clones to confirm the sequence match. This process was done for all guide RNA vectors.

3.3 Creation of KO cell lines

3.3.1 Lentiviral production

Human embryonic kidney cells 293T (HEK293T) were cultured in DMEM medium (Dulbecco's Modified Eagle Medium; (*PAN-Biotech*)) complete with

10% fetal bovine serum (FBS; (*PAN-Biotech*)) and penicillin and streptomycin mix. Cells were kept in cell culture incubator at 37°C, 5%CO₂. Prior to seeding cells were counted using a haemocytometer. In short, cells were trypsinised with 2x trypsin (*Gibco*) and centrifuged at 1200 rpm (revolutions per minute). Supernatant was discarded and pelleted cells were resuspended in fresh DMEM complete. 10µl of cell suspension was loaded between haemocytometer and the cover glass. Cells in a square were counted. Total number of cells was calculated using a formula:

$$\text{No. of cells} \times \text{dilution factor} \times \text{total volume} \times 10^4$$

Calculated volume was taken out of the stock and seeded.

LentiCRISPR v2 plasmids with gRNA inserts were co-transfected with packaging plasmids PmD2.G and psPAX2 into HEK293T cells. PmD2.G is envelope expressing plasmid, while psPAX2 supplies structural and enzymatic proteins of the virus. Co-transfection was done using calcium phosphate method. One million cells were seeded in a 6 well plate in DMEM complete. Cells were incubated overnight in cell culture incubator. The following morning a mixture of three transfection plasmids was prepared in ration 5µg lentiCRISPR v2: 3,75µg psPAX: 1,25µg pMD2.G 4:3:1 in water. The mixture was added into 2,5µM CaCl₂, mixed well and incubated for 5 minutes at room temperature. Following incubation, the Ca²⁺-DNA solution was added dropwise into 500µl of HBS by vortexing and incubated for 30 minutes at room temperature. After, the mixture was added dropwise to the cells. The medium was replaced the following day and cells were observed. Lentivirus was harvested on day 3 post-transfection.

3.3.2 Transduction into target cells

One day prior to transduction, one million cells were seeded in a 6 well plate in DMEM complete. Medium with produced lentivirus was collected in a syringe and filtered through a 0,45µm POS filter. A filter attached to open syringe barrel was placed on top of a 50ml Falcon tube. Viral supernatant was collected and transferred inside a setup and filtered with a plunger. Filtered supernatant was added to appropriate wells. Transduction of guides was carried out on two cell lines: HEK293T and HEK293A.

3.3.3 Antibiotic selection

Transduced and control cells were put under antibiotic selection with puromycin. Briefly, puromycin was added to DMEM in ratio of 1:10 000. Existing DMEM medium was replaced with puromycin treated DMEM complete and cells were put in cell culture incubator. Treated cells were observed regularly, and puromycin medium was replaced and cells were split as needed. Once all non-transduced cells in the control well had died due to effects of puromycin, antibiotic selection was deemed complete. Surviving cells were expanded and samples were collected for analysis.

3.4 Analysis of KO success

3.4.1 Western blot

Once cells were expanded, 500 000 were collected for Western blot analysis. Cells were counted as previously described, and appropriate fraction was centrifuged at 10 000 x g for 5 minutes at 4°C. Supernatant was removed and pellet was resuspended in 50µl of RIPA ('Radioimmunoprecipitation assay') buffer. Mixture was spun again at the same settings as before. Resulting supernatant was transferred into fresh Eppendorf tube kept on ice and 50µl of

2X Laemmli Sample Buffer (*Santa Cruz*) was added. Samples were mixed with the buffer by pipetting and heated on a heat block at 95°C for 6 minutes. Once the samples were heated, they were loaded on a gel for SDS-PAGE ('Sodium dodecyl-sulfate polyacrylamide gel electrophoresis').

Samples were run on 10% SDS polyacrylamide gel. Polyacrylamide gel consist of resolving gel (2,4ml dH₂O, 1,25ml acrylamide (*Roth*), 1,25 ml resolving buffer (5M Tris (pH 8,8)), 50µl 10% SDS (pH 6,6), 50µl 10% APS, 5µl TEMED (*Roth*)) and stacking gel (1,8ml dH₂O, 313µl acrylamide (*Roth*), 315µl stacking buffer (1M Tris (pH 6,8)), 25µl 10% SDS (pH 6,6), 25µl 10% APS, 2,5µl TEMED (*Roth*)). Firstly, gel casting apparatus (*Bio-Rad*) was assembled. 1mm spacer glass plate and glass cover were inserted into the casting frame and secured. Casting frame was clamped into casting stand. Resolving gel was prepared first. Isopropanol was added on top and the gel was left to solidify. Once solidified, isopropanol was removed and freshly prepared stacking gel was poured on top. 1mm comb was inserted into the stacking gel to form the wells, and the gel was left to solidify. Once the gel was cast, it was released from the gel casting apparatus and put onto the gel support with cover glass plate facing inwards. Second gel is placed similarly on the other side and the gel support was locked. The assembly is put in electrophoresis tank (*Bio-Rad*). Inner and outer buffer chambers were filled with 1x running buffer (25mM Tris, 192 mM glycine, 0,1% SDS (pH 8,3)) and the gel was run using *Bio-Rad* power supply on 80V until samples ran through stacking gel, when the power was increased to 120V.

Once the run was complete, gel was carefully removed from the glass plates and soaked in 1x transfer buffer (25mM Tris, 12 mM glycine, 20% methanol). A 'blotting sandwich' was prepared for wet transfer, consisting of anode, 3 pieces of blotting paper, a nitrocellulose membrane (*Macherey-Nagel*), a gel followed by another 3 pieces of blotting paper and finally a cathode. This setup

was placed in a tank filled with 1x transfer buffer and transfer was run at 30mA for 75 minutes.

Once wet transfer was finished, membrane was stained with Ponceau S (0,1% Ponceau S in 1% acetic acid) and protein presence was visualised. Membrane was then blocked in milk (5%) for 30 minutes before being put in appropriate primary antibody overnight (1:1000 ADAR1 (*Cell Signalling*), 1:1000 ADAR1 p150(*Cell Signalling*), 1:100 ADAR2 (*Santa Cruz*), 1:100 ADAR3 (*Santa Cruz*), 1:100 RED2 (*Novus Biologicals*), β -Actin (*Cell Signalling*) in 5% milk). Following incubation in primary antibody membrane was washed 3 times for 10 minutes in 1x TBS (150 mM NaCl, 10 mM Tris (pH 8,0)) before incubation in appropriate secondary antibody: 1:2000 Anti-rabbit IgG, HRP-linked Antibody (*Cell Signalling*) for ADAR1, ADAR1 p150, RED2 and β -Actin primary antibodies; 1:2000 Anti-mouse IgG, HRP-linked Antibody (*Cell Signalling*) for ADAR2 and ADAR3 primary antibodies. Following 1 hour incubation membrane was washed as described above and visualised and documented using *ChemiDoc MP* imaging system (*Bio-Rad*).

3.4.2 Immunofluorescence

Coverslips were placed in wells using suction pump. Coverslips were coated with *Matrigel* (*Corning*) prepared 1:100 in DMEM lacking FBS. Slides were firmly pressed to the bottom with a pipette tip to avoid formation of any air bubbles. Once coated, slides were placed in cell culture incubator overnight.

Cells were counted as described above. 200 000 cells were seeded in 12 well on top of coated slides and left to attach overnight in incubator. The following morning media was aspirated and cells were fixed with 3,7% PFA for 20 minutes at room temperature. Once cells were fixed, they were washed 3 times for 5 minutes with PBS. After washing cells were permeabilised with 0,1%

Triton X-100 in PBS for 5 minutes at room temperature, then washed again as described before. Blocking was done with 1% BSA and 0,1% Tween-20 in PBS for 30 minutes at 37°C. During blocking antibody dilution was prepared (1:100 ADAR1 (*Cell Signalling*) in 1% BSA and 0,1% Tween-20 in PBS). Diluted antibody was dotted on parafilm. Following blocking, coverslips were placed on top of the antibody drop with cells facing down. Parafilm with glasses was placed in a humidified chamber and incubated for 1 hour at 37°C. After incubation cells were again washed as described before. Secondary antibody was diluted (1:500 anti-rabbit Alexa Fluor 488 (*Cell Signalling*)), applied, incubated and then washed in the same manner as primary antibody. Following washing of the secondary antibody DAPI was applied for 1 minute (1:1000 in PBS). After a minute, DAPI (*Cell Signalling*) was washed 3 times as described before. Mounting medium was added dropwise to cover slides. Coverslips were thoroughly dried and firmly placed on mounting medium with cells facing down. Cells were visualised and documented using *Zeiss* imaging system.

4. RESULTS

4.1 Restriction digestion of backbone

To diminish ADAR1 protein expression in HEK293 cells we applied CRISPR/Cas9 technology. Commercial lentiCRISPR v2 plasmid vector (*Addgene*) was used as a cloning vector according to published protocol by Zhang laboratory. Briefly, it contains expression cassettes for *S. pyogenes* CRISPR/Cas9 nuclease and for guide RNA. The lentiviral vector has specific cut sites for BsmBI enzyme. Once the vector is cut, the CRISPR guides with correct 3' PAM sequence are cloned into the guide RNA scaffold (27). Visual representation of BsmBI digested lentiCRISPR v2 with guide RNA inserts was made using SnapGene software. The plasmid also carries ampicillin (AMP; 100 µg/ml) and puromycin (PURO) resistance genes. The plasmid is shown in Figure 4.

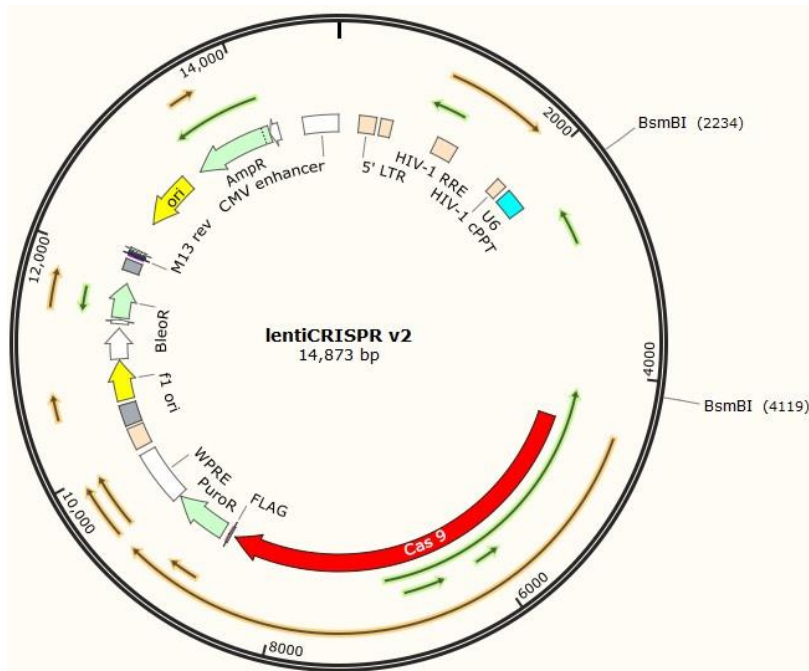

Figure 4: Schematic representation of plasmid vector lentiCRISPR v2.

Plasmid vector lentiCRISPR v2 has expression cassettes for gRNA under control of U6 promoter and *S. pyogenes* Cas9 (marked red) as well as ampicillin and puromycin resistance genes (marked green). Additionally, it has SV40

promoter enabling increased protein expression in HEK293T cells. Finally, it has a common sequencing primer, M13 rev. There are two designated cut sites for BsmBI. Figure was generated using SnapGene.

Vector backbone lentiCRISPR v2 has designated cut sites for BsmBI enzyme. This produces two bands on the agarose gel. Restriction digestion reaction was loaded into 3 wells on the gel to dilute the sample and make the bands sharper and easier to excise from the gel. The top band is the digested empty vector with the expected size of 12 992 bp. The empty vector was cut and eluted from the gel. The bottom band is fragment that is discarded, with the expected size of 1885 bp. Linearised lentiCRISPR v2 vector was used for cloning DNA fragment encoding gRNAs as described in the Materials and Methods, i.e. in the place of a discarded fragment, a guide RNA is inserted. Uncut vector was used as a control. The two bands present in the sample are its undigested form (top band) and likely a supercoiled form (bottom band). The size of the top band is visibly larger than that of the empty vector and roughly corresponds to the size of uncut vector. The bottom band is visibly smaller than the empty vector yet is significantly larger than discarded fragments. All things considered, restriction digestion was deemed successful.

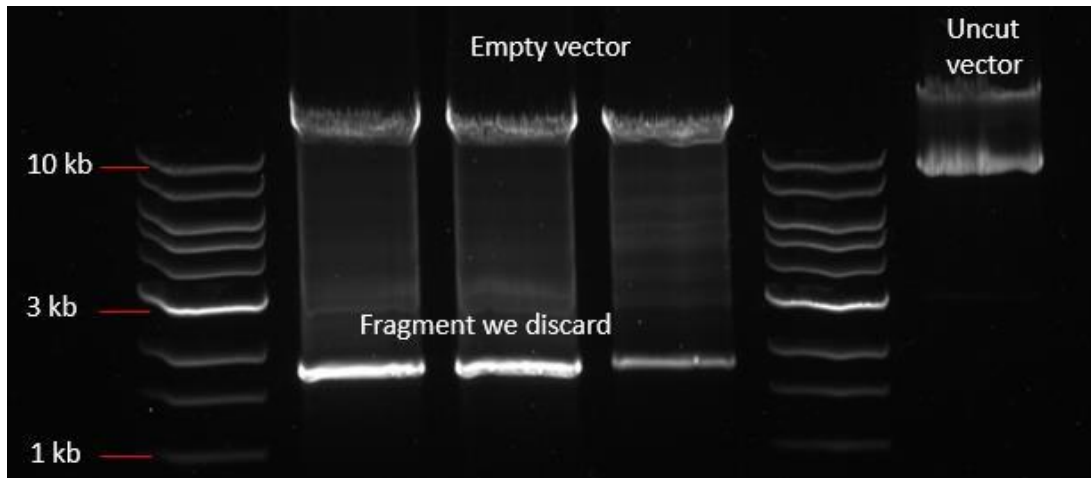

Figure 5: Restriction digestion of lentiCRISPR v2 with BsmBI. Vector was cut with BsmBI. Restriction digestion reaction was run on 0,8% agarose gel, with uncut vector used as control. Ladder size is indicated on the side. Empty vector – digested lentiCRISPR v2, Fragment we discard – discarded fragment, Uncut vector – untreated vector (control).

4.2 Check restriction digestion of annealed guides shows potential successful insertions

A check restriction digestion was done to check if the insertion of gRNAs was successful. Briefly, following bacterial transformation, 3 or 4 colonies were picked for analysis for each target guide. After plasmid purification, check restriction digestion with BamHI and PmeI enzymes was carried out on all plasmids. The two enzymes cut at two places without disturbing insertion site. Cut with these two enzymes creates two distinct fragments (Figure 6A).

Four clones were picked for ADAR1 guide 1 ('ADAR1 g1'). The bands are of correct sizes, top one being the size of 11 432 bp and the bottom one the size of 1581 bp. Plasmid DNA of clone A had a lower yield than other three samples,

which is reflected as two faint bands on the gel. Control for this reaction is missing (Figure 6B).

Plasmids from three clones were prepared in larger quantities, i.e. midi prepped and checked for ADAR1 guide 2 and both guides for ADAR2. Vector linearised with EcoRI was used as a control, with expected size of 14 873 bp. Only clone C of ADAR1 guide2 ('ADAR1 g2 C') has the expected two bands. The other two clones (A and B) show only one band of unexpected size. As such, they were discarded. Samples of ADAR2 guide 1 and ADAR2 guide 2 only show one clone with correct bands per different gRNA as well ('ADAR2 g1 C; ADAR2 g2 B'). Other clones show a band of unexpected size as well, which was discarded as possible cross-contamination with another vector (Figure 6C).

Four clones were sampled for each ADAR3 guide. Diluted uncut vector backbone was loaded as a control. All clones show two bands of expected sizes (Figure 6 D). All clones that showed expected band sizes were sent for sequencing.

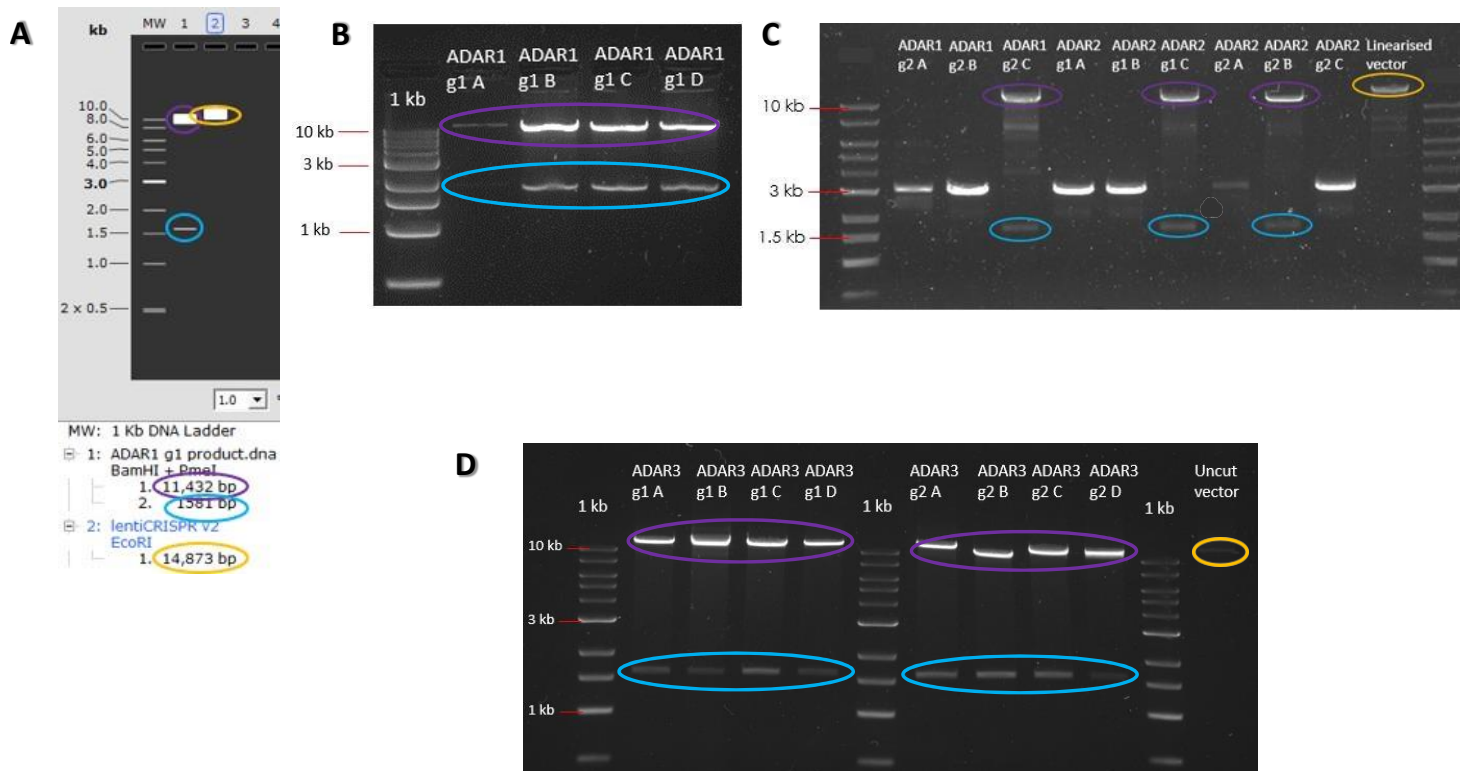

Figure 6: Check restriction digestion of annealed guides shows potential successful insertions. A number of clones of each ADAR gRNA was cultured and purified. Restriction digestion with BamHI and PmeI was done. **A** Agarose gel simulation of restriction digestion with expected band sizes. Simulation was done in SnapGene. **(B-D)** Agarose gel analysis of restriction digestion. Bands of correct sizes are indicated in matching colours. Purple – 11,342 bp fragment, blue- 1581 bp fragment, yellow – linearised lentiCRISPR v2, ADAR1 g1 (A,B,C,D) – ADAR1 guide 1 (clone A,B,C,D), ADAR1 g2 (A,B,C) – ADAR1 guide 2 (clone A,B,C), ADAR2 g1 (A,B,C) – ADAR2 guide 1 (clone A,B,C), ADAR2 g2 (A,B,C) – ADAR2 guide 2 (clone A,B,C), Linearised vector – lentiCRISPR v2 linearised with EcoRI, ADAR3 g1 (A,B,C,D) – ADAR3 guide 1 (clone A,B,C,D), ADAR3 g2 (A,B,C,D) – ADAR3 guide 2 (clone A, B,C,D), Uncut vector – purified lentiCRISPR v2.

4.3 Sequencing results confirm successful cloning

Plasmids showing the expected restriction digest were sequenced by *Macrogen Europe* using Sanger sequencing to confirm cloning of the exact gRNAs. Sequencing results were analysed in *Clone Manager*. Expected sequence of each vector with guide inserts was compared with respective clones to confirm successful insertion.

Part of the sequence marked with red square contains gRNA inserts. The topmost sequence is the expected sequence, while underneath are sequenced clones. All clones of ADAR1 guide 1 show a match to expected sequence (Figure 7A).

Only one clone per guide was sent for sequencing for samples ADAR1 guide 2, ADAR2 guide 1 and ADAR2 guide 2. Alignment for these clones showed successful insertion of gRNA (Figure 7B,C,D).

All clones of ADAR3 guide 1 showed presence of undigested vector and as such were discarded as unsuccessful. Cloning process was repeated. After check restriction digestion (data not shown) one guide was identified and sent for sequencing ('ADAR3 g1'). Sequencing analysis confirmed successful insertion (Figure 7E). Two clones of ADAR3 guide 2 matched expected sequence, as shown in Figure 7F. Clones A and C contain undigested vector (data not shown). All successful clones miss one A nucleotide when compared the expected sequence, indicating a point mutation in the expected DNA sequence. Regardless, as this is located before gRNA insert, it was discarded as irrelevant.

A

```
ADAR1 g1 expecte 1 tggactatcatatgcttacgtaacttgaaagtatttcgatttcttgctttatatacttgggaaaggacgaaa caccggtatatactcgggccttggtagttt tagagctagaa
ADAR1 g1 clone A 1 -----agcgaaa-----tcca-ttcttgctttatatacttgggaaaggacgaaa caccggtatatactcgggccttggtagttt tagagctagaa
ADAR1 g1 clone B 1 -----gcgga-----tcgatt--ctggctttatatacttgggaaaggacgaaa caccggtatatactcgggccttggtagttt tagagctagaa
ADAR1 g1 clone C 1 -----gcgga-----tacga-ttcttgctttatatacttgggaaaggacgaaa caccggtatatactcgggccttggtagttt tagagctagaa
ADAR1 g1 clone D 1 -----acgga-----tcgatttcttgctttatatacttgggaaaggacgaaa caccggtatatactcgggccttggtagttt tagagctagaa
```

B

```
ADAR1 g2 product 1 tatcatatgcttacgtaacttgaaagtatttcgatttcttgctttatatacttgggaaaggacgaaa caccgtgactcctctgccctgaattgttt tagagct:
ADAR1 g2 C 1 -----gca-----tcgaat--ctggctttatatacttgggaaaggacgaaa caccgtgactcctctgccctgaattgttt tagagct:
```

C

```
ADAR2 g1 product 1 atcatatgcttacgtaacttgaaagtatttcgatttcttgctttatatacttgggaaaggacgaaa caccgtgtgaaggaaaaccgcaatcgttt tagagctaga
ADAR2 g1 clone C 1 -----gcgatcggatttcttgctttatatacttgggaaaggacgaaa caccgtgtgaaggaaaaccgcaatcgttt tagagctaga
```

D

```
ADAR2 g2 product 1 atcatatgcttacgtaacttgaaagtatttcgatttcttgctttatatacttgggaaaggacgaaa caccgtctggacaacgtgtccccagttt tagagctaga
ADAR2 g2 clone B 1 -----gcaatcgatt--ctggctttatatacttgggaaaggacgaaa caccgtctggacaacgtgtccccagttt tagagctaga
```

E

```
ADAR3 g1 expecte 1 atcatatgcttacgtaacttgaaagtatttcg---atttcttgcttt-atatacttgggaaaggacgaaa caccgggtgaatgactgccacgcggttt tagagct:
ADAR3 g1 1 -----aggaattcggaaatggctaggctttatatacttgggaaaggacgaaa caccgggtgaatgactgccacgcggttt tagagct:
```

F

```
ADAR3 g2 expecte 1 atcatatgcttacgtaacttgaaagtatttcgatttcttgctttatatacttgggaaaggacgaaa caacggcaacggctacgggaaagacgggttt tagagct:
ADAR3 g2 E 1 -----gggatcgatt--ctggctttatatacttgggaaaggacgaaa caacggcaacggctacgggaaagacgggttt tagagct:
ASAR3 g2 D 1 -----gggga-----tcgatt--ctggctttatatacttgggaaaggacgaaa caacggcaacggctacgggaaagacgggttt tagagct:
```

Figure 7: Sequencing results confirm successful cloning. All clones with correctly sized bands were sent for sequencing. (A-F) Sequencing results were compared to expected sequence generated in SnapGene for each guide. Comparison was done using CloneManager. Part of sequence containing gRNA insert is marked by red square.

4.4 CRISPR/Cas9 successfully knocks out p150 isoform in HEK293A cells

Successfully cloned gRNAs were used to generate lentiviral vectors to ablate ADAR1 expression. HEK293 cells were transduced and selected according to protocol described in the Materials and Methods. After selection with puromycin, HEK293A and HEK293T cell lines were both tested for successful KO of ADAR1 using two antibodies: ADAR1 that detects both isoforms of the protein and ADAR1 p150 antibody that is specific to p150 isoform. Blotting of HEK293A with ADAR1 p150 antibody shows presence of the expected band only in control samples (Figure 8A). Re-blotting with ADAR1 antibody shows visible bands corresponding to p150 isoform in both controls used. There is no band corresponding to p150 isoform in KO cells. All samples show p110 isoform band (Figure 8B). Actin blotting shows protein levels in samples (Figure 8C). Taken together, Western blot indicates CRISPR/Cas9 KO of ADAR1 p150 isoform is successful.

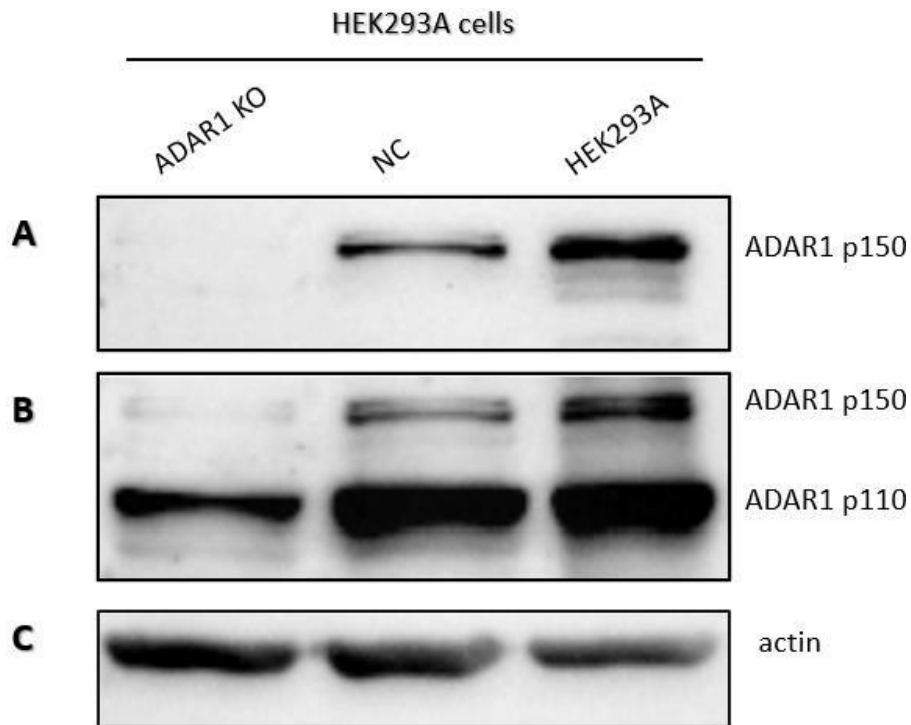

Figure 8: Successful KO of ADAR1 p150 isoform. ADAR1 KO, NC and HEK293A cells were analysed for ADAR1 protein presence. **A** Western blot of samples stained with ADAR1 p150 antibody. **B** Western blot of samples stained with ADAR1 antibody. **C** Western blot of samples stained for actin. ADAR1 KO – Cells knocked out for ADAR1, NC – cells with scramble sequence control, HEK293A – control cells.

4.5 Unsuccessful KO of ADAR1 in HEK293T cells

When stained with ADAR1 antibody, HEK293T cells showed the presence of both isoforms. There were three controls used for this experiment: ADAR1 KO cells obtained from Ghent University (a kind gift from prof. Johnatan Maelfait), 'negative control' (NC), and untreated HEK293T cells (HEK293T). The topmost band represents p150 isoform. Although the band is quite faint in KO sample, it is present in all control samples in the same manner as well, and only lacking in Ghent ADAR1 KO sample (Figure 9A). Re-blotting of samples with ADAR1

p150 antibody confirmed the presence of a larger isoform in attempted KO sample and confirmed no presence of it in Ghent ADAR1 KO cells used as control (data not shown). ADAR1 p110 isoform is present after both blottings in attempted KO cells as well as all control cells. The band is not present only in Ghent ADAR1 KO sample. Therefore, it was concluded that the KO attempt was not successful in these cells. Ponceau S staining was done to confirm the presence of protein (Figure 9B).

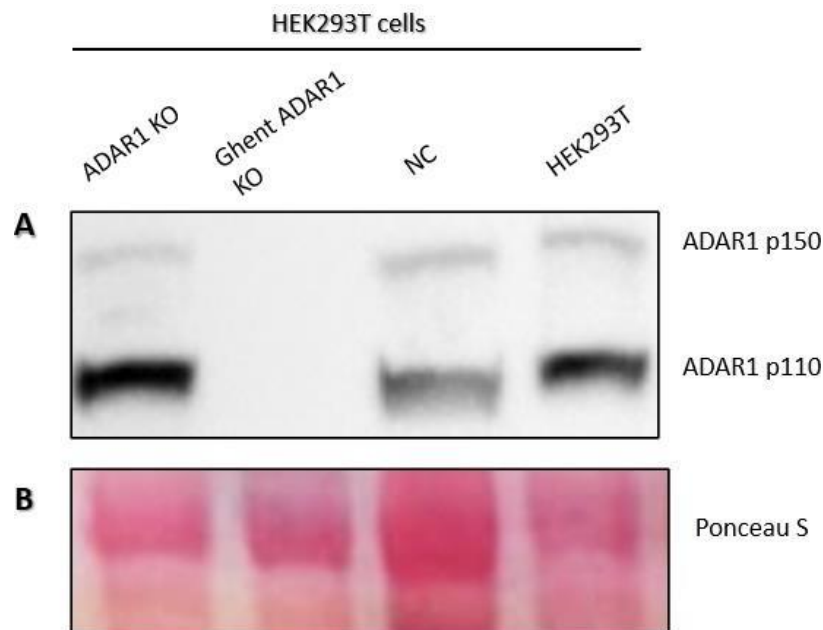

Figure 9: ADAR1 KO is unsuccessful in HEK293T cells. ADAR1 KO, Ghent ADAR1 KO, NC and HEK293T cells were analysed for ADAR1 protein presence. **A** Western blot of samples stained with ADAR1 antibody. **B** Western blot of samples stained with Ponceau S. ADAR1 KO – cells knocked out for ADAR1, Ghent ADAR1 KO – cells lacking ADAR1 gifted from Ghent University, NC – cells with scramble sequence control, HEK293T – control cells.

4.6 Immunofluorescence does not show clear difference

Immunofluorescence was done on HEK293A cells to further confirm KO success. Cells were stained with DAPI and ADAR1 antibody. DAPI (4',6-diamidino-2-phenylindole) is a fluorescent stain that binds to AT regions of dsDNA and is therefore used for visualisation of nucleus (28). Negative control was used as control cell line in this experiment. Merged pictures of DAPI and ADAR1 slightly less presence of ADAR1 in KO cells when compared to NC (Figure 10). However, as ADAR1 antibody stains both p110 and p150 it is hard to conclude a positive KO based on immunofluorescence.

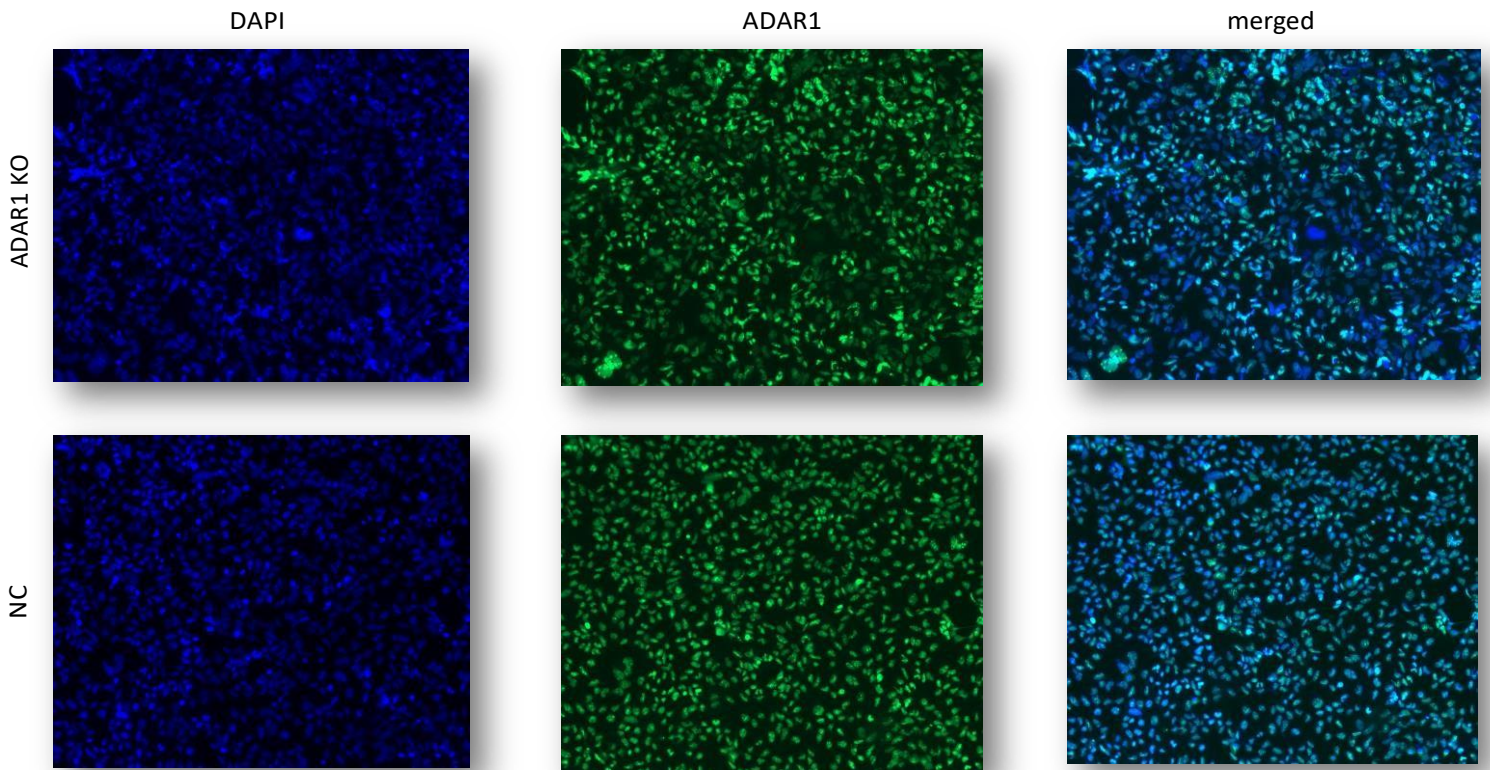

Figure 10: Immunofluorescence does not show clear difference. ADAR1 KO and NC cells were stained with DAPI and ADAR1 antibody. Imaging was done using Zeiss software. ADAR1 KO – Cells knocked out for ADAR1, NC – cells with scramble sequence control.

4.7 ADAR2 KO was not successful

Transduction of ADAR2 guides was unsuccessful in HEK293A cell line and cells did not survive whereas transduction of guides into HEK293T cell line was successful. Three clones were isolated and grown, as well as a mixed population colony of KO cells. Untreated HEK293T cells as well as NC were used as control. Although there are no bands in the control lysate, mixed population and all clones as well as NC show bands of expected sizes (Figure 11A). Actin blotting confirms protein levels in all samples (Figure 11B). Therefore, it was concluded that ADAR2 KO was not achieved.

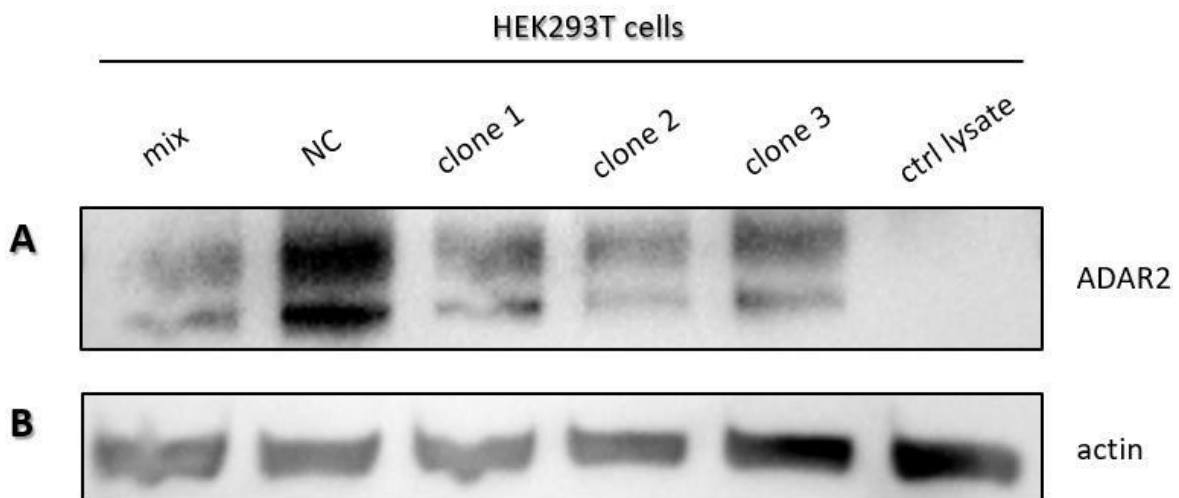

Figure 11: ADAR2 KO was not successful. Mixed culture of ADAR2 KO cells, NC, three ADAR2 KO clones and HEK293T cells were analysed for ADAR2 protein presence. **A** Western blot of samples stained with ADAR2 antibody. **B** Western blot of samples stained for actin. mix – mixed culture of cells knocked out for ADAR2, NC – cells with scramble sequence control, clone (1,2,3) – clonal colonies of cells lacking ADAR2, ctrl lysate – control HEK293T cells.

4.8 ADAR3 was not detected

As with ADAR2 guides, ADAR3 transduction was ineffective in HEK293A cells. Transduction in HEK293T cell line proved to be successful, however no colony clones were successfully obtained. Two different Western blot antibodies were used to analyse ADAR3 KO lysates. Neither antibody produced any bands in both KO and control samples (Figure 12A) although Ponceau S staining shows protein presence (Figure 12B).

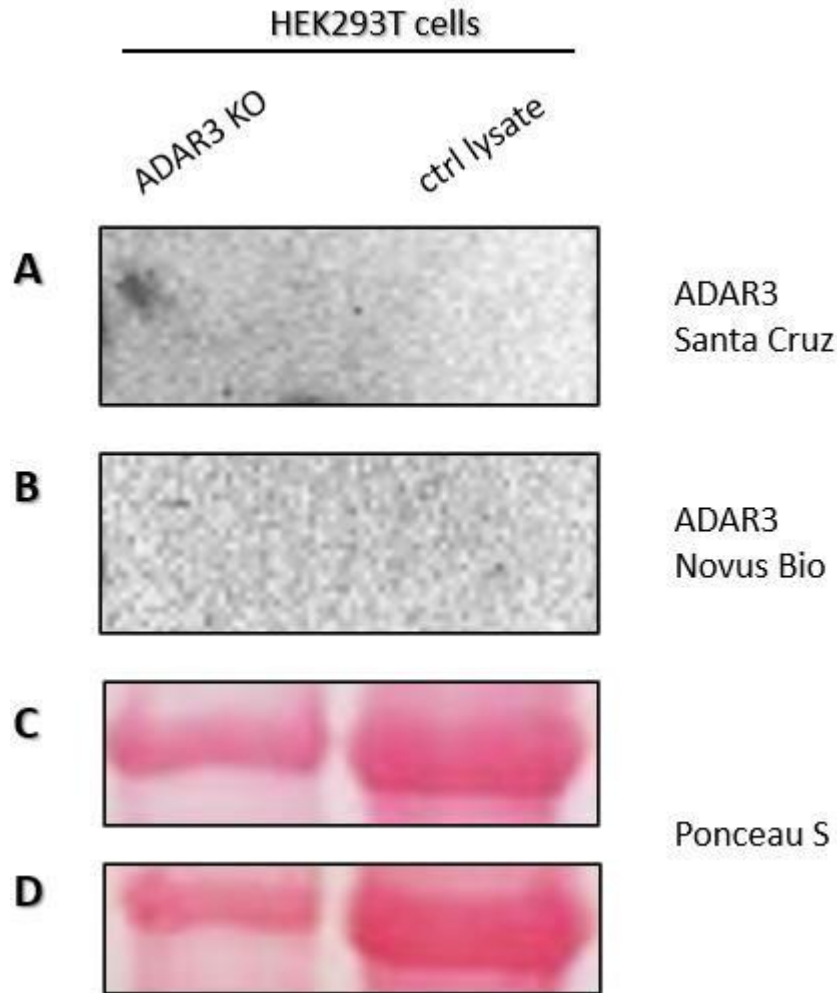

Figure 12: ADAR3 was not detected. ADAR3 KO and control HEK293T cells were analysed for ADAR3 protein presence. **A** Western blot of samples stained with *Santa Cruz* ADAR3 antibody. **B** Western blot of samples stained with *Novus Biologicals* ADAR3 antibody. (**C-D**) Western blot of samples stained with Ponceau S. ADAR3 KO – cells knocked out for ADAR3, ctrl lysate – control cells, ADAR3 Santa Cruz – *Santa Cruz* ADAR3 antibody, ADAR3 Novus Bio - *Novus Biologicals* ADAR3 antibody.

5. DISCUSSION

This work aimed to generate vectors for ablation of ADAR proteins in different cells, for the purpose of exploring their role in infection with common human pathogen HSV-1. We used HEK293 cells that have previously been shown to survive without ADAR1 expression. However, our efforts with CRISPR/Cas9 KO were only partially successfully implemented in this cell line, where a KO of one ADAR1 isoform, p150 was achieved. KO was confirmed using only Western blot technique where results clearly indicate lack of the expected band in KO sample. Immunofluorescence on same sample was inconclusive, however, as antibody used is not isoform specific and as such detects both nuclear p110, and nuclear and cytoplasmic p150. This interferes with result analysis, as it is not possible to clearly visualise difference between KO and control cells. Therefore, immunofluorescence was dismissed as an additional method of confirmation. As p150 is involved in innate immune response (11), interferon β could be used to induce it in both KO and control cells. Following treatment, cells could be tested for elevated p150 levels using Western blot. Additionally, RT-PCR could be used to test the expression of mRNA levels. Lower to no expression of ADAR1 p150 isoform is expected in KO samples, whereas increased levels should be observed in control. In contrast, p110 levels are not expected to change in all samples as it does not play a role in interferon β response (29).

RNA guides for ADAR1 (named ADAR1 guide 1 and ADAR1 guide 2) target exon 2. As this exon is shared between both isoforms, a complete ablation of ADAR1 was expected to occur. However, as only one guide was successfully taken up, it would seem the target site disabled p150 isoform production. This phenomenon was recorded by Cenci et al 2008 in paediatric astrocytomas. A deletion spanning 136 nucleotides within ADAR1 exon 2 triggered a previously unreported splicing event. Consequently, this modification induced a frameshift in the ADAR1 150 transcript, ultimately leading to the selective

synthesis of the ADAR1 110-kDa protein (30). This might have happened during our CRISPR/Cas9 KO, however this should be further confirmed. Sequencing of ADAR1 gene in p150 KO cell line could help identify the guide responsible for ablation and elucidate if the deletion is of a similar nature to the one found in paediatric astrocytomas.

Successful knock out of only one ADAR1 isoform implicates that one RNA guide for ADAR1 KO was successfully integrated into the CRISPR machinery, while integration of other failed. ADAR2 KO attempt seems to have failed completely. As these guide sequences were taken from a reported successful knockouts, these results are unexpected.

Even though the gene-editing tool precisely identifies its target location on the DNA, there are instances when it can still fail to do so (31). Numerous factors can impact the effectiveness of CRISPR-Cas systems in genome editing. These include repair mechanisms for double-strand breaks (DSBs), the design of guide RNA sequences, unintended side effects, and the efficiency of delivery methods, among others (32). Furthermore, CRISPR-Cas9 can occasionally exhibit errors by binding to locations other than its intended target sequence (31). The potential off-target occurrences arise from the CRISPR/Cas9 complex's tendency to bind to DNA indiscriminately, even with seed sequence similarities as small as five nucleotides. Ongoing efforts to address this issue involve the development of modified Cas9 variants that display diminished off-target effects (OTEs), as well as the refinement of guide RNA designs. As one of the potential solutions to this issue, Cas9 variants that decrease off-target effects (OTEs) while upholding editing efficiency have been developed (32).

Conditional gene KO of ADAR genes could be generated. Numerous techniques have emerged to enable conditional expression of CRISPR/Cas9. Initial methods on manipulating the protein itself, but in recent times, there has been a growing emphasis on modifying the gRNA, offering unique possibilities.

Limiting the ability to manipulate the genome within a specific timeframe serves not only to decrease off-target effects and genotoxicity but also offers a crucial tool to investigate dynamics of regulatory networks. Utilizing small molecule-induced decaging permits the time-controlled activation of CRISPR/Cas9 function by applying an external stimulus (33). One such example are systems of drug induction acting at the transcriptional level. This category relies on the regulation of Cas9 or gRNA transcription using drug-responsive promoters, such as doxycycline (dox)-induced Tet system. It is one of the most used drug-inducible transgene expression system. It works by releasing the *Escherichia coli* Tet repressor protein (TetR) from its bound tet operator (TetO) sequence when tetracycline or its derivative, doxycycline, is introduced (34). The Tet-On system has been utilized to control the expression of either Cas9 or sgRNA (35).

HEK293 cells are commonly used in academic research due to their convenient growth and transfection characteristics. High transfection efficiency of HEK293 cells facilitates the generation of exogenous proteins or viruses for applications in pharmaceutical and biomedical research. Lately, HEK293 cells have garnered interest for their versatility in transfection experiments, particularly in the amplification of adenoviral-based and retroviral-based vectors. HEK293T is a derivative of HEK293 cells engineered to carry a temperature-sensitive version of the SV40 T antigen. This modification allows for the enhancement of vector amplification that contains the SV40 ORI (origin of replication), leading to a significant boost in protein expression levels during short-term transfection (36). As transfection was done in HEK293T cells, it is unlikely this step of KO was unsuccessful.

ADAR3 protein was not detectable by either antibody used, therefore it is not possible to confirm KO using Western blot method. Low protein levels could be due to the fact that expression of ADAR3 is mostly restricted to the brain, while

KO was done in kidney cell line where the expression levels are low. Another way to test for a KO would be using RT-PCR, as it is a more sensitive technique.

6. CONCLUSION

The importance of editing and ADAR proteins in the context of double-stranded DNA infection is understudied and seems to vary. This project aimed to create vector ablation of ADARs expression and knockout cell lines that lack specific ADAR proteins, with the goal of investigating their involvement in the infection process of the prevalent human pathogen HSV-1. The approach entailed generation of cell lines without ADAR proteins using CRISPR/Cas9 technology. We have successfully generated all planned vectors and performed selection with antibiotics. However, knockout of ADAR2 protein was not successful while only partial knockout of ADAR1 was achieved. There are possibilities to improve the CRISPR/Cas9 KO, mainly to repeat the attempts using conditional expression of the CRISPR system via doxycycline. Knockout of ADAR3 remains to be confirmed, as expression levels in HEK293T cells are too low to be detected by Western Blot. RT-PCR could be used to measure mRNA levels of ADAR3 in KO and control cells as this technique is more sensitive than protein detection. Interferon inducible isoform of ADAR1 was successfully ablated. Although immunofluorescence did not provide conclusive confirmation of KO, this cell line could be treated with interferon β instead. RT-PCR results of KO cells are not expected show induction of p150 isoform, further confirming KO. The generation of cell line lacking this specific isoform opens an intriguing possibility of testing the role of p150 in infection with HSV-1 and by extension, in infection with dsDNA viruses.

7. REFERENCES

1. Khosravi HM, Jantsch MF. Site-directed RNA editing: recent advances and open challenges. *RNA Biol* [Internet]. 2021;18(sup1):41–50. Available from: <https://www.ncbi.nlm.nih.gov/pmc/articles/PMC8677011/>
2. Fan H. Retroviruses [Internet]. Schaechter M, editor. ScienceDirect. Academic Press; 2009. 519-534 PP-Oxford p. Available from: <https://www.sciencedirect.com/science/article/abs/pii/B9780123739445003151>
3. Smith M. 4 - Gene and environment interactions and phenotypes [Internet]. Smith M, editor. ScienceDirect. Academic Press; 2020. p. 79–107. Available from: <https://www.sciencedirect.com/science/article/abs/pii/B9780128196137000049>
4. Salter JD, Bennett RP, Smith HC. The APOBEC Protein Family: United by Structure, Divergent in Function. *Trends Biochem Sci*. 2016;41(7):578–94.
5. Pfaller CK, George CX, Samuel CE. Adenosine Deaminases Acting on RNA (ADARs) and Viral Infections. *Annu Rev Virol* [Internet]. 2021 Sep 29;8(1):239–64. Available from: <https://www.annualreviews.org/doi/10.1146/annurev-virology-091919-065320>
6. Sun T, Yu Y, Wu X, Acevedo A, Luo J-D, Wang J, et al. Decoupling expression and editing preferences of ADAR1 p150 and p110 isoforms. *Proc Natl Acad Sci*. 2021;118(12).
7. Pfaller CK, Li Z, George CX, Samuel CE. Protein kinase PKR and RNA adenosine deaminase ADAR1: new roles for old players as modulators

- of the interferon response. *Curr Opin Immunol.* 2011;23(5):573–82.
8. Mladenova D, Barry G, Konen LM, Pineda SS, Guennewig B, Avesson L, et al. Adar3 Is Involved in Learning and Memory in Mice. *Front Neurosci.* 2018;12.
 9. Wang Y, Chung DY, Monteleone LR, Li J, Chiang Y-C, Toney MF, et al. RNA binding candidates for human ADAR3 from substrates of a gain of function mutant expressed in neuronal cells. *Nucleic Acids Res.* 2019;47(20):10801–14.
 10. Yu Z, Chen T, Cao X. RNA editing by ADAR1 marks dsRNA as “self.” *Cell Res.* 2015;25(12):1283–4.
 11. Lamers MM, van den Hoogen BG, Haagmans BL. ADAR1: “Editor-in-Chief” of Cytoplasmic Innate Immunity. *Front Immunol.* 2019;10(10).
 12. Destefanis E, Avşar G, Groza P, Romitelli A, Torrini S, Pir P, et al. A mark of disease: how mRNA modifications shape genetic and acquired pathologies. *RNA.* 2020;27(4):367–89.
 13. Samuel CE. ADARs: Viruses and Innate Immunity. *Curr Top Microbiol Immunol.* 2011;163–95.
 14. Slotkin W, Nishikura K. Adenosine-to-inosine RNA editing and human disease. *Genome Med.* 2013;5(11):105.
 15. Vollmar W, Gloger J, Berger E, Kortenbruck G, Köhling R, Speckmann E-J, et al. RNA editing (R/G site) and flip–flop splicing of the AMPA receptor subunit GluR2 in nervous tissue of epilepsy patients. *Neurobiol Dis.* 2004;15(2):371–9.
 16. Ringlander J, Fingal J, Kann H, Prakash K, Rydell G, Andersson M, et al. Impact of ADAR-induced editing of minor viral RNA populations on replication and transmission of SARS-CoV-2. *Proc Natl Acad Sci U S A*

- [Internet]. 2022;119(6):e2112663119. Available from:
<https://pubmed.ncbi.nlm.nih.gov/35064076/>
17. Matešić M, Zubković A, Đukić N, Mihalac J, Jurak I. Puzzling functions of HSV-1 miRNAs in productive and latent infection. *Period Biol.* 2020;121–122(3–4):107–13.
 18. Cokarić Brdovčak M, Zubković A, Ferenčić A, Šoša I, Stemberga V, Cuculić D, et al. Herpes simplex virus 1 miRNA sequence variations in latently infected human trigeminal ganglia. *Virus Res* [Internet]. 2018;256:90–5. Available from:
<https://www.sciencedirect.com/science/article/abs/pii/S0168170218300947?via%3Dihub>
 19. Cong L, Ran FA, Cox D, Lin S, Barretto R, Habib N, et al. Multiplex Genome Engineering Using CRISPR/Cas Systems. *Science* (80-) [Internet]. 2013;339(6121):819–23. Available from:
<https://pubmed.ncbi.nlm.nih.gov/23287718/>
 20. Barrangou R, Fremaux C, Deveau H, Richards M, Boyaval P, Moineau S, et al. CRISPR provides acquired resistance against viruses in prokaryotes. *Science*. 2007;315(5819):1709–12 PP-United States.
 21. Bondy-Denomy J, Pawluk A, Maxwell KL, Davidson AR. Bacteriophage genes that inactivate the CRISPR/Cas bacterial immune system. *Nature* [Internet]. 2013;493(7432):429–32. Available from:
<https://www.ncbi.nlm.nih.gov/pubmed/23242138>
 22. Khan SH. Genome editing technologies: Concept, pros and cons of various genome editing techniques and bioethical concerns for clinical application. *Mol Ther - Nucleic Acids*. 2019;16(16).
 23. Trevino AE, Zhang F. Genome editing using Cas9 nickases. *Methods*

- Enzymol [Internet]. 2014;546:161–74. Available from:
<https://pubmed.ncbi.nlm.nih.gov/25398340/>
24. Kleinstiver BP, Pattanayak V, Prew MS, Tsai SQ, Nguyen NT, Zheng Z, et al. High-fidelity CRISPR–Cas9 nucleases with no detectable genome-wide off-target effects. *Nature*. 2016;529(7587):490–5.
 25. Abdelnour SA, Xie L, Hassanin AA, Zuo E, Lu Y. The Potential of CRISPR/Cas9 Gene Editing as a Treatment Strategy for Inherited Diseases. *Front Cell Dev Biol*. 2021;9.
 26. Chung H, Calis JJA, Wu X, Sun T, Yu Y, Sarbanes SL, et al. Human ADAR1 Prevents Endogenous RNA from Triggering Translational Shutdown. *Cell* [Internet]. 2018;172(4):811-824.e14. Available from:
<https://pubmed.ncbi.nlm.nih.gov/29395325/>
 27. LentiCRISPRv2 and lentiGuide-Puro: lentiviral CRISPR/Cas9 and single guide RNA. Available from:
https://media.addgene.org/data/plasmids/52/52961/52961-attachment_B3xTwla0bkYD.pdf
 28. DAPI (4',6-diamidino-2-phenylindole) - US [Internet].
www.thermofisher.com. 2023. Available from:
<https://www.thermofisher.com/hr/en/home/life-science/cell-analysis/fluorophores/dapi-stain.html>
 29. George CX, Samuel CE. Human RNA-specific adenosine deaminase *ADAR1* transcripts possess alternative exon 1 structures that initiate from different promoters, one constitutively active and the other interferon inducible. *Proc Natl Acad Sci* [Internet]. 1999;96(8):4621–6. Available from:
<https://europepmc.org/backend/ptpmcrender.fcgi?accid=PMC16382&blobtype=pdf>

30. Cenci C, Barzotti R, Galeano F, Corbelli S, Rota R, Massimi L, et al. Down-regulation of RNA Editing in Pediatric Astrocytomas. *J Biol Chem*. 2008;283(11):7251–60.
31. Liu W, Li L, Jiang J, Wu M, Lin P. Applications and challenges of CRISPR-Cas gene-editing to disease treatment in clinics. *Precis Clin Med* [Internet]. 2021;4(3):179–91. Available from: <https://www.ncbi.nlm.nih.gov/pmc/articles/PMC8444435/>
32. Uddin F, Rudin CM, Sen T. CRISPR Gene Therapy: Applications, Limitations, and Implications for the Future. *Front Oncol*. 2020;10(1387).
33. Brown W, Zhou W, Deiters A. Regulating CRISPR/Cas9 Function through Conditional Guide RNA Control. *ChemBioChem*. 2020;
34. Zhou X, Vink M, Klaver B, Berkhout B, Das AT. Optimization of the Tet-On system for regulated gene expression through viral evolution. *Gene Ther*. 2006;13(19):1382–90.
35. Zhang J, Chen L, Zhang J, Wang Y. Drug Inducible CRISPR/Cas Systems. *Comput Struct Biotechnol J*. 2019;17:1171–7.
36. Yuan J, Xu WW, Jiang S, Yu H, Poon HF. The Scattered Twelve Tribes of HEK293. *Biomed Pharmacol J* [Internet]. 2018;11(2):621–3. Available from: <https://biomedpharmajournal.org/vol11no2/the-scattered-twelve-tribes-of-hek293/>

8. SUPPLEMENTAL DATA

| <i>gRNA</i> | <i>gRNA sequence</i> | <i>Target gene</i> |
|---------------|--|--------------------|
| ADAR1 guide 1 | Fw: CACCGTTATATCTCGGGCCTTGGTA Rev: AAACCTACCAAGGCCCGAGATATAAC | ADAR1 |
| ADAR1 guide 2 | Fw: CACCGTGACTCCTCTGCCCTGAATT Rev: AAACAATTCAGGGCAGAGGAGTCAC | ADAR1 |
| ADAR2 guide 1 | Fw: CACCGTGTGAAGGAAAACCGCAATC Rev: AAACGATTGCGGTTTTCTTCACAC | ADAR2 |
| ADAR2 guide 2 | Fw: CACCGTCTGGACAACGTGTCCCCCA Rev: AAACCTGGGGGACACGTTGTCCAGAC | ADAR2 |
| ADAR3 guide 1 | Fw: CACCGGGTGAATGACTGCCACGCGG Rev: AAACCCGCGTGGCAGTCATTCACCC | ADAR3 |
| ADAR3 guide 2 | Fw: CACCGCACCGCTACCGCGAAGACCG Rev: AAACCGGTCTTCGCGGTAGCGGTGC | ADAR3 |

Table S1: Guide RNA (gRNA) sequences for all three ADAR genes.

Vlatka Ivanišević
Jarnovićeva 52, 10 000
ZagrebCroatia
Mobile: 00 385 97 665
4485

Email: vlatka.ivanisevic@student.uniri.hr | LinkedIn: [Vlatka Ivanišević](#)

PERSONAL PROFILE

A master's student in MRes Biotechnology for the Life Sciences at University of Rijeka. Highly motivated to dedicate professional life and personal passion to furthering knowledge and skills of molecular biology. Hardworking, a team player and dedicated to achieving the best results. Keen to gain experience in new areas and determined to learn and progress in the workplace. Currently seeking a position in laboratories involving molecular biology.

EDUCATION

Master of Research in Biotechnology for the Life Sciences

University of Rijeka (2021 – 2023)

Rijeka, Croatia

Performed two lab rotations as a part of the degree.

Relevant modules include: Statistics, Scientific Writing, Intellectual Property and Project Management.

Relevant experience and skills:

Laboratory of Molecular Virology

Master thesis project – Knockout of ADAR1, ADAR2 and ADAR3 genes using CRISPR/Cas9

- guide design
- cloning
- transfection using Lipofectamine 2000 and calcium phosphate; transduction, lentivirus handling
- cell culture basics (splitting, seeding, counting, Matrigel coating)
- Western blot, sample preparation
- qPCR, RNA isolation, cDNA library prep
- immunofluorescence

Laboratory rotation - Worked on HSV-1 resistance to acyclovir in herpetic keratitis

- PCR
- gel electrophoresis
- gel extraction
- sequencing analysis

Laboratory of Behavioural Genetics

Laboratory rotation – worked with *Drosophila melanogaster*

- propagation, selection and maintenance of flies
- FlyCafe and FlyBong assays (*Drosophila* behavioural tests)

Volunteering – Worked on detecting PER and TIM circadian proteins in *Drosophila* brains

Bachelor of Science in Human Biosciences

Coventry University (2015 – 2018)

Coventry, UK

Relevant modules include: Cell and Molecular Biology, Human Genetics, Human Development, Infection and Immunity, Biochemistry and Microbiology, Anatomy and Physiology and Research design for Biomolecular Sciences.

Igor Morozov's laboratory

Final year project – The role of nucleotidyltransferases in decapping of mRNAs in *Aspergillus nidulans*

- RNA purification using phenol-chlorophorm extraction, ethanol precipitation
- DNase1 and XRN1 treatment, RT- PCR
- Calculation of levels of expression and t-test, graphs

Relevant experience and skills:

- aseptic technique, Health and Safety procedures, COSHH form, Risk Assessment form
- microbial streak plate technique, use of selective and indicator media, staining techniques, microbial identification
- ELISA, antibiotic sensitivity tests, complement mediated cell lysis
- flow cytometry, histology staining, mammalian cell culture
- Lowry protein assay, Bradford protein assay, gel filtration chromatography, SDS-PAGE

KEY SKILLS

Communication

- Fluent in Croatian (first language) and English in reading, speaking and writing, basic German knowledge
- Experienced in preparing scientific reports to a high standard of written English
- Presented reports at lab meetings, participated in journal clubs
- Was a contact person as a member of Erasmus Student Network (ESN)

Team Working and Organisation

- Basic mentoring of incoming lab members, experience through cooperation in joint laboratory tasks
- Ability to work efficiently in a team during group projects, multitasking

IT & Data Analysis

- Proficient in the use of Microsoft Word, PowerPoint, Excel and Outlook
- SnapGene, Clone Manager

POSTERS & ABSTRACTS

BMS Student conference (2018) – Comparing levels of capped and decapped mRNA in *A. nidulans* wild type, uaZ and *gdhA* transcripts ([presenter](#))

ESCRS 2022 – Analysis Of Hsv-1 Genome In Corneal Scrapings Of Patients With Different Hsv Keratitis Forms In Croatia

PosteRi student symposium (2022) – Dissecting ADAR1-2-3 roles in HSV-1 infection using CRISPR/Cas9 knockout technology ([presenter](#))

8th European congress of virology (2023) – ADAR1 Prevents HSV-1 from Triggering Translational Shutdown and is required for efficient viral replication

International Herpesvirus Workshop (2023) – ADAR1 Prevents HSV-1 from Triggering PKR-mediated Translational Shutdown and is required for efficient viral replication

ADDITIONAL ACHIEVEMENTS

- Trained artistic swimming for 10 years, and competed in both City and State Championships every year. Competed in all disciplines over the years (solo, duet, team, combination)
- Competed in several international competitions, two of them as a part of National Team
- Won a gold medal at Istanbul International Cup in 2011
- Science outreach – Department Open day (2022)

WORK EXPERIENCE

- English tutor, Customer care agent
-

REFERENCES

Igor Jurak, PhD, University of Rijeka igor.jurak@biotech.uniri.hr

Mia Cesarec, PhD, University of Rijeka mia.cesarec@biotech.uniri.hr

Ana Filošević Vujnović, PhD, University of Rijeka ana.filosevic@biotech.uniri.hr